



Residence Lofts Krizikova



CAPITAL TRUST, a.s.

tel: +420 602 649 490  
tel: +420 775 560 871

[martin.urman@cinzovnidomy.cz](mailto:martin.urman@cinzovnidomy.cz)  
[salesmanager@cinzovnidomy.cz](mailto:salesmanager@cinzovnidomy.cz)

[www.cinzovnidomy.cz](http://www.cinzovnidomy.cz)  
[www.loftskrizikova.eu](http://www.loftskrizikova.eu)

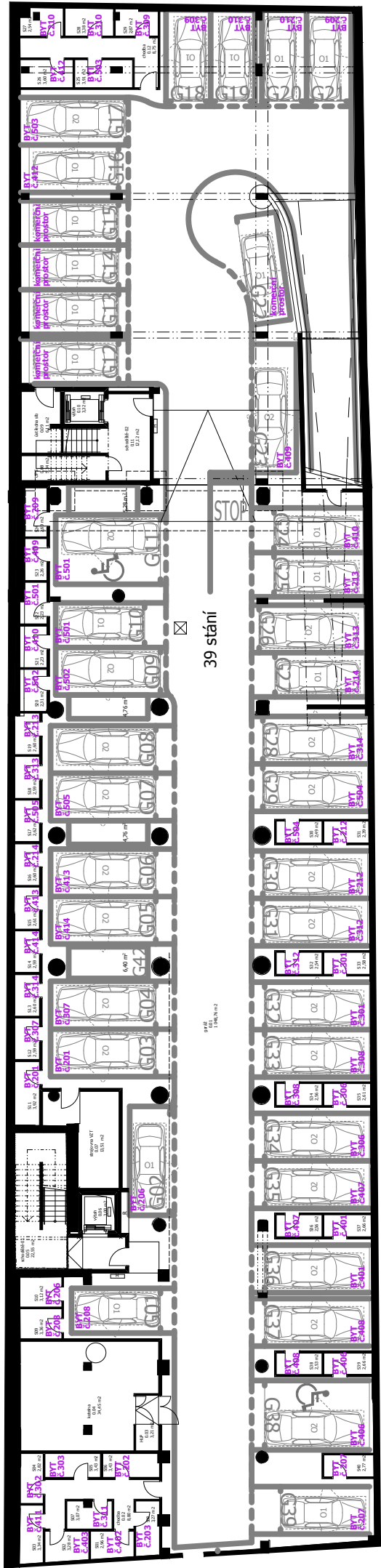
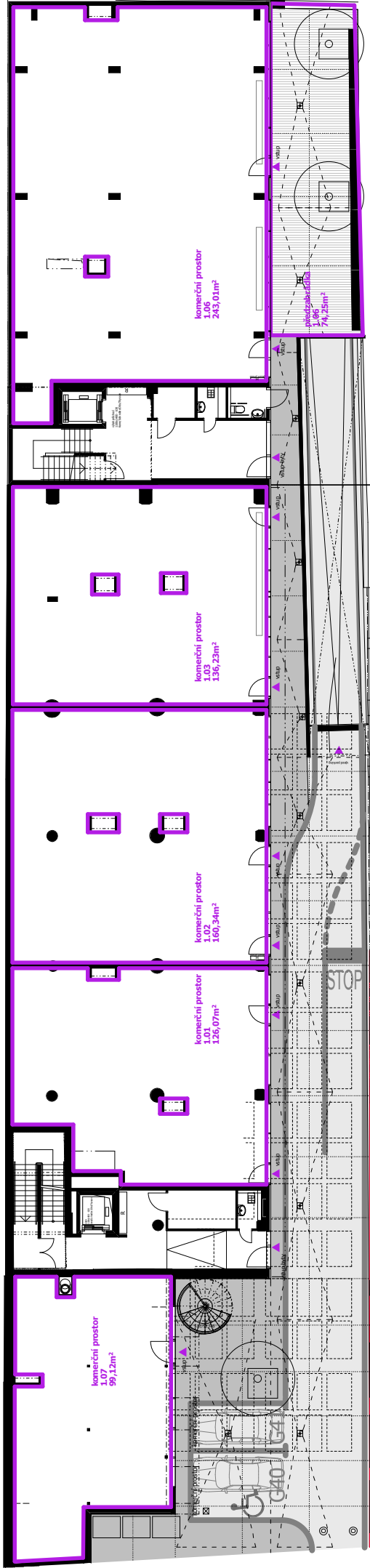

0 2 5 10  
1:200

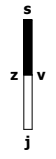

Residence Lofts Krizikova

1. nadzemní podlaží



1. podzemní podlaží

CAPITAL TRUST, a.s.  
tel: +420 602 649 490  
tel: +420 775 560 871

martin.urman@cinzovnidomy.cz  
salesmanager@cinzovnidomy.cz

www.cinzovnidomy.cz  
www.loftskrizikova.eu

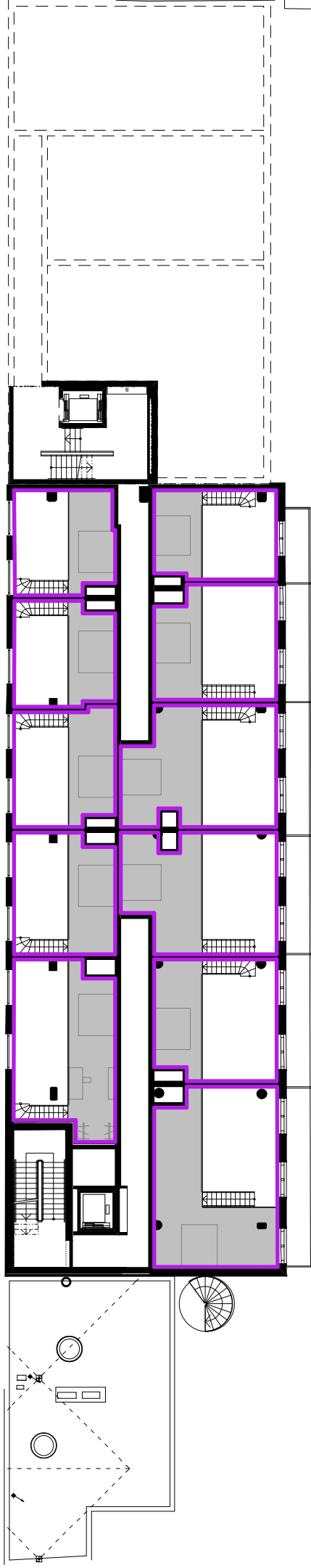

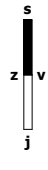
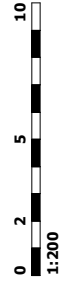
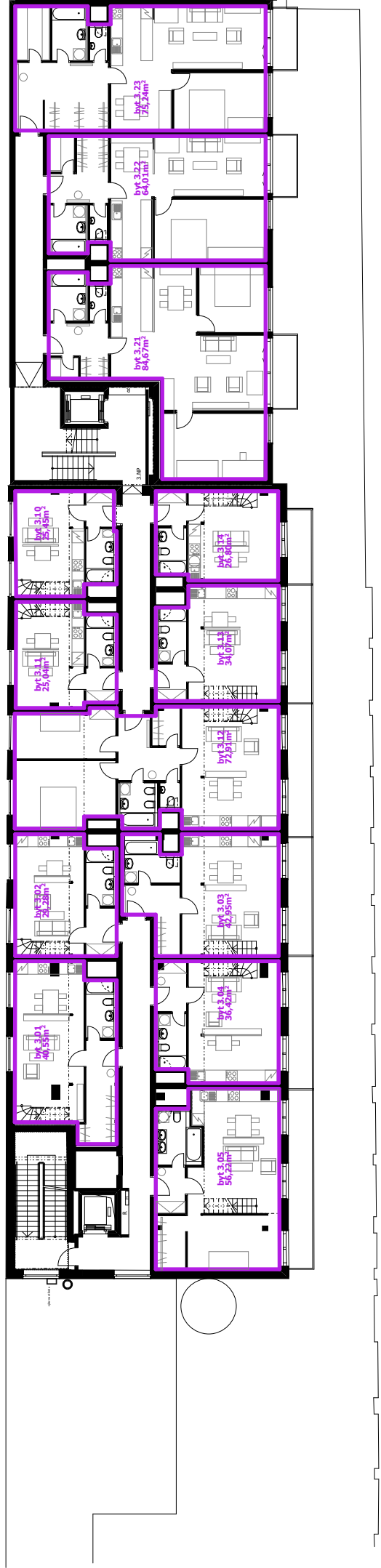
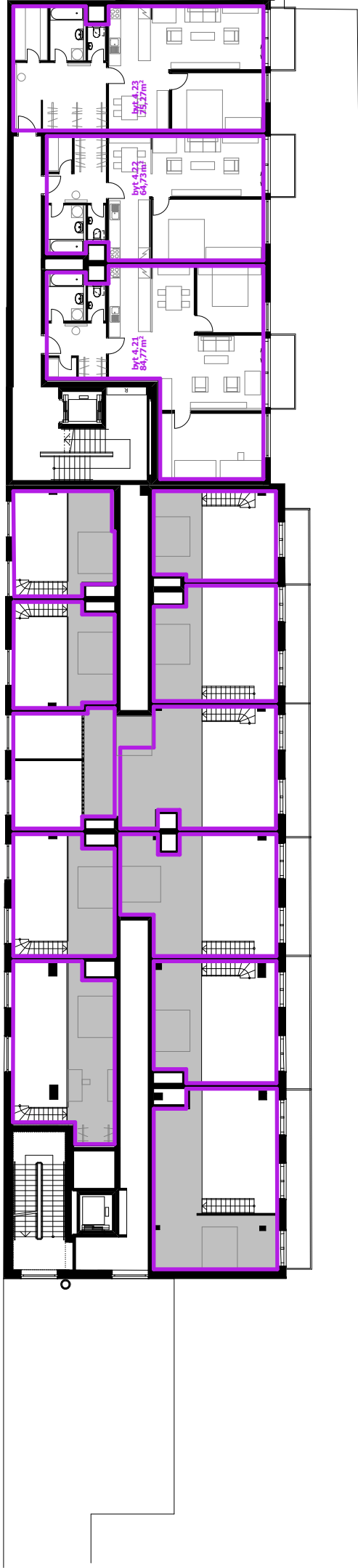

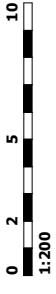
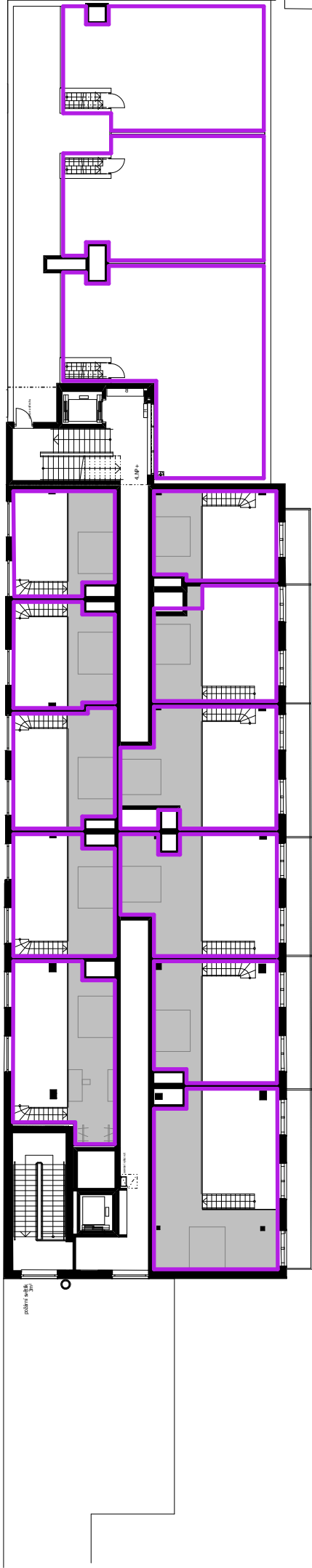

Residence Lofts Krizikova

4. nadzemní podlaží



CAPITAL TRUST, a.s.

tel: +420 602 649 490  
tel: +420 775 560 871

martin.urman@cinzovnidomy.cz  
salesmanager@cinzovnidomy.cz

www.cinzovnidomy.cz  
www.loftskrizikova.eu

podlaží ve výšce 3m

1:200

1:200

1:200

1:200

1:200

1:200

1:200

1:200

1:200

1:200

1:200

1:200

1:200

1:200

1:200

1:200

1:200

1:200

1:200

1:200

1:200

1:200

1:200

1:200

1:200

1:200

1:200

1:200

1:200

1:200

1:200

1:200

1:200

1:200

1:200

1:200

1:200

1:200

1:200

1:200

1:200

byt 5.10  
25,10m<sup>2</sup>

byt 5.11  
25,12m<sup>2</sup>

byt 5.12  
24,45m<sup>2</sup>

byt 5.13  
26,64m<sup>2</sup>

byt 5.14  
33,99m<sup>2</sup>

byt 5.15  
42,33m<sup>2</sup>

byt 5.16  
24,63m<sup>2</sup>

byt 5.17  
24,56m<sup>2</sup>

byt 5.18  
36,30m<sup>2</sup>

byt 5.19  
54,45m<sup>2</sup>

byt 5.20  
36,30m<sup>2</sup>

byt 5.21  
89,02m<sup>2</sup>

byt 5.22  
84,63m<sup>2</sup>

byt 5.23  
72,89m<sup>2</sup>

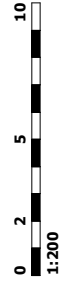
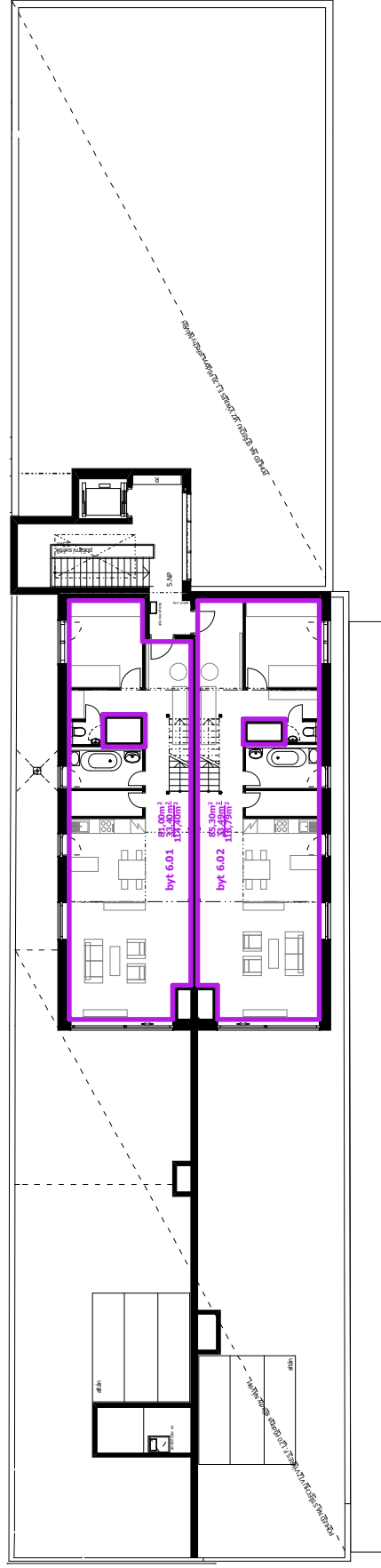
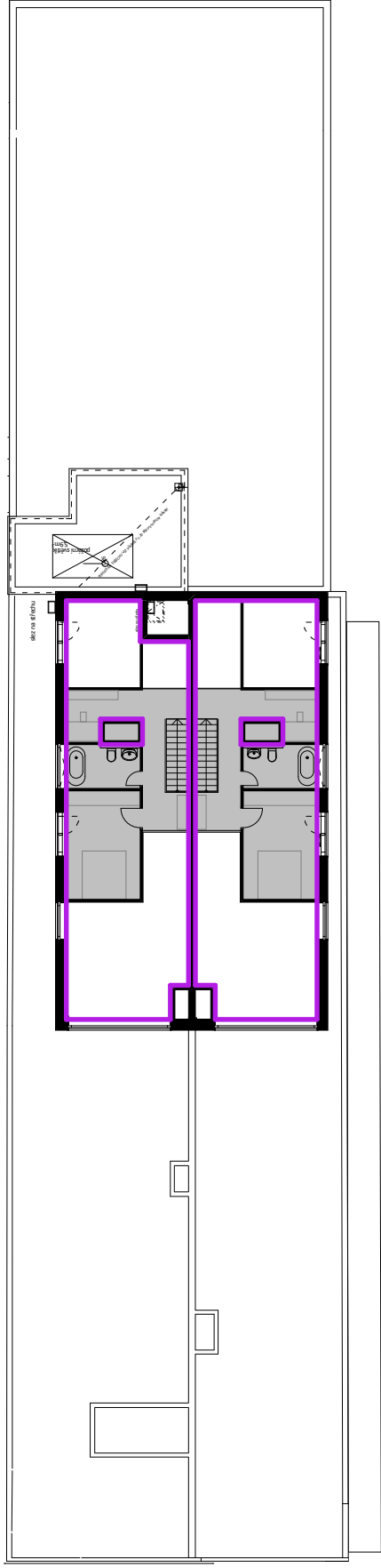

Residence Lofts Krizikova

5. nadzemní podlaží



CAPITAL TRUST, a.s.  
tel: +420 602 649 490  
tel: +420 775 560 871

martin.urman@cinzovnidomy.cz  
salesmanager@cinzovnidomy.cz

www.cinzovnidomy.cz  
www.loftskrizikova.eu

# komerční prostory



Rezidence Lofts Krizikova



CAPITAL TRUST, a.s.

tel: +420 602 649 490  
tel: +420 775 560 871

[martin.urman@cinzovnidomy.cz](mailto:martin.urman@cinzovnidomy.cz)  
[salesmanager@cinzovnidomy.cz](mailto:salesmanager@cinzovnidomy.cz)

[www.cinzovnidomy.cz](http://www.cinzovnidomy.cz)  
[www.loftskrizikova.eu](http://www.loftskrizikova.eu)

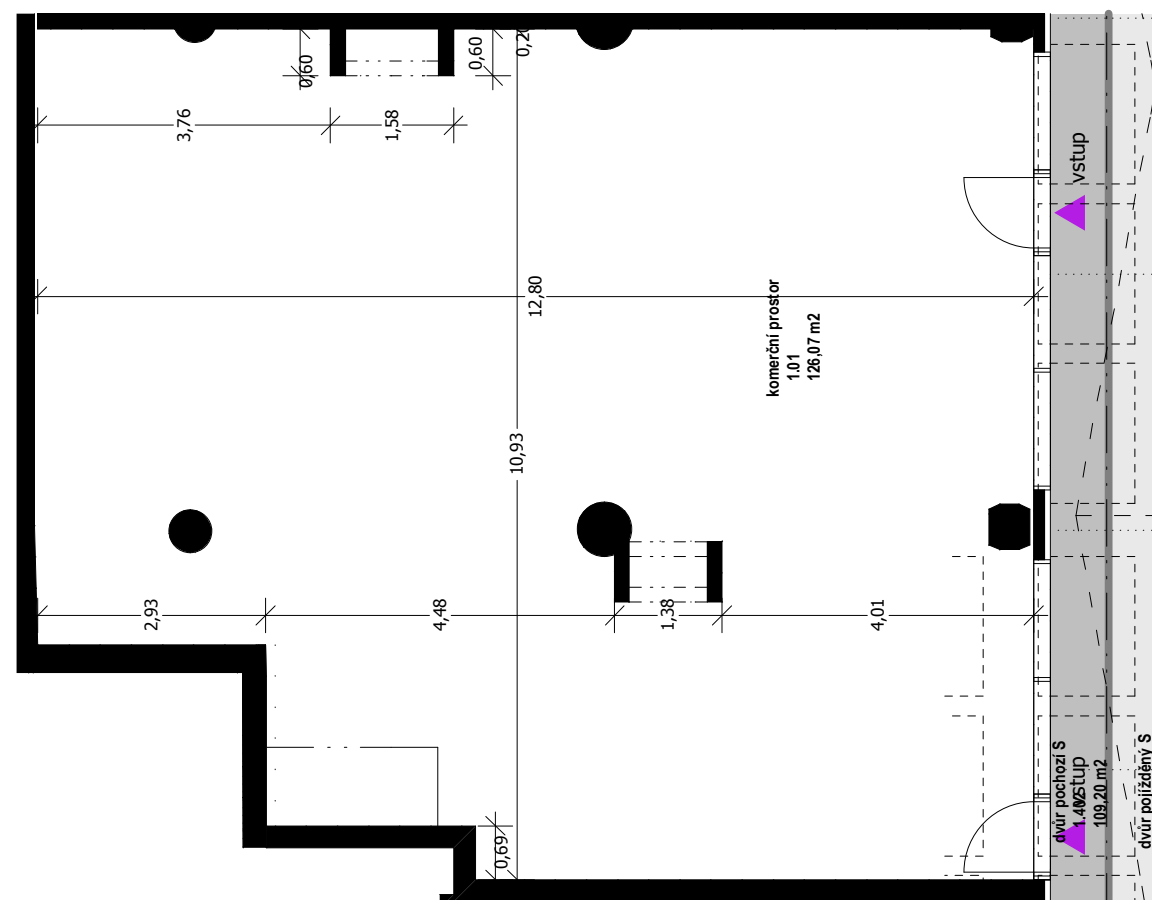
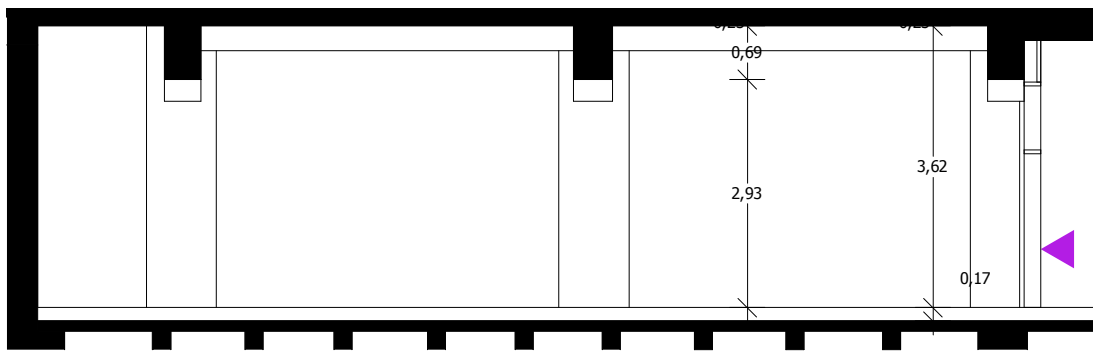

## 1. nadzemní podlaží

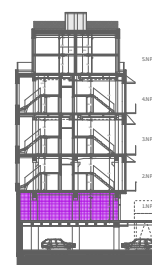

typ: komerční prostor  
 orientace: východ  
 plocha: 126,07m<sup>2</sup>  
 terasa: -  
 garážové stání volitelně  
 sklep ne  
 jednotka:



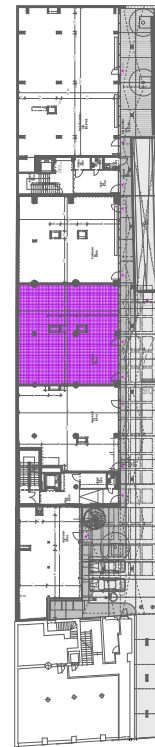
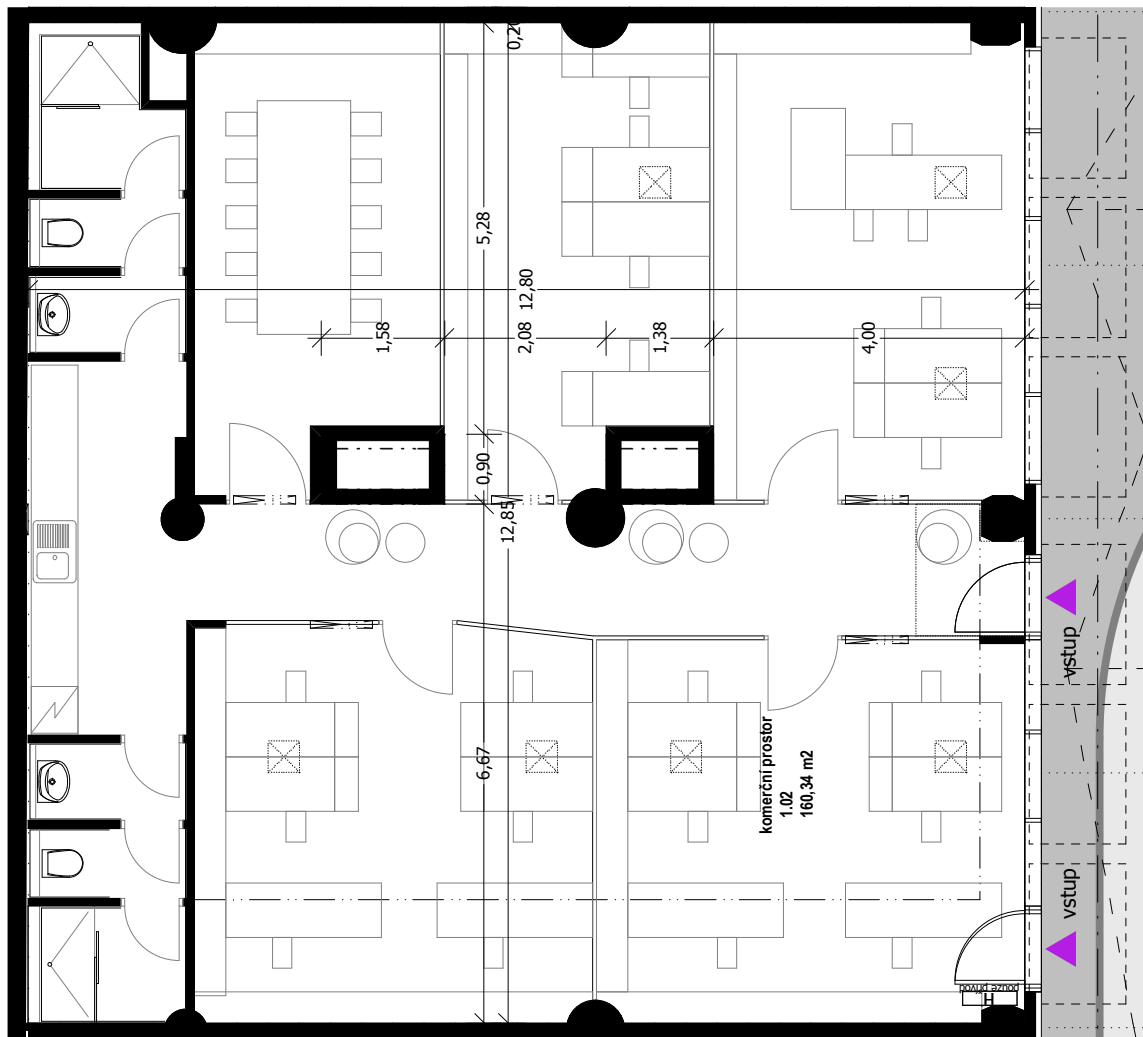
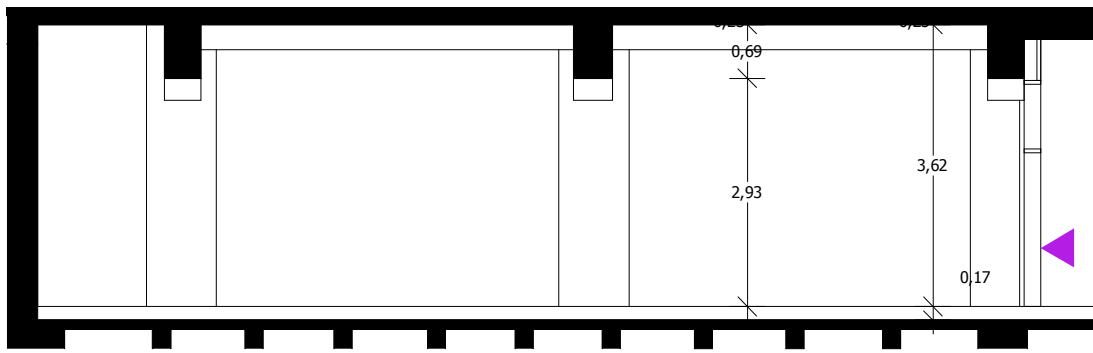

## 1. nadzemní podlaží

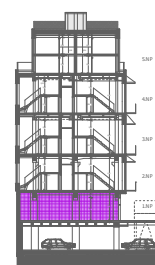

**typ:** komerční prostor  
**orientace:** východ  
**plocha:** 160,34m<sup>2</sup>  
**terasa:** -  
**garážové stání** volitelně  
**sklep** ne  
**jednotka:**

Residence Lofts Krizikova

RESIDENCE LOFTS  
KRIZIKOVA

1.02

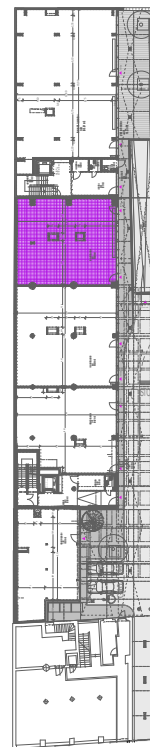
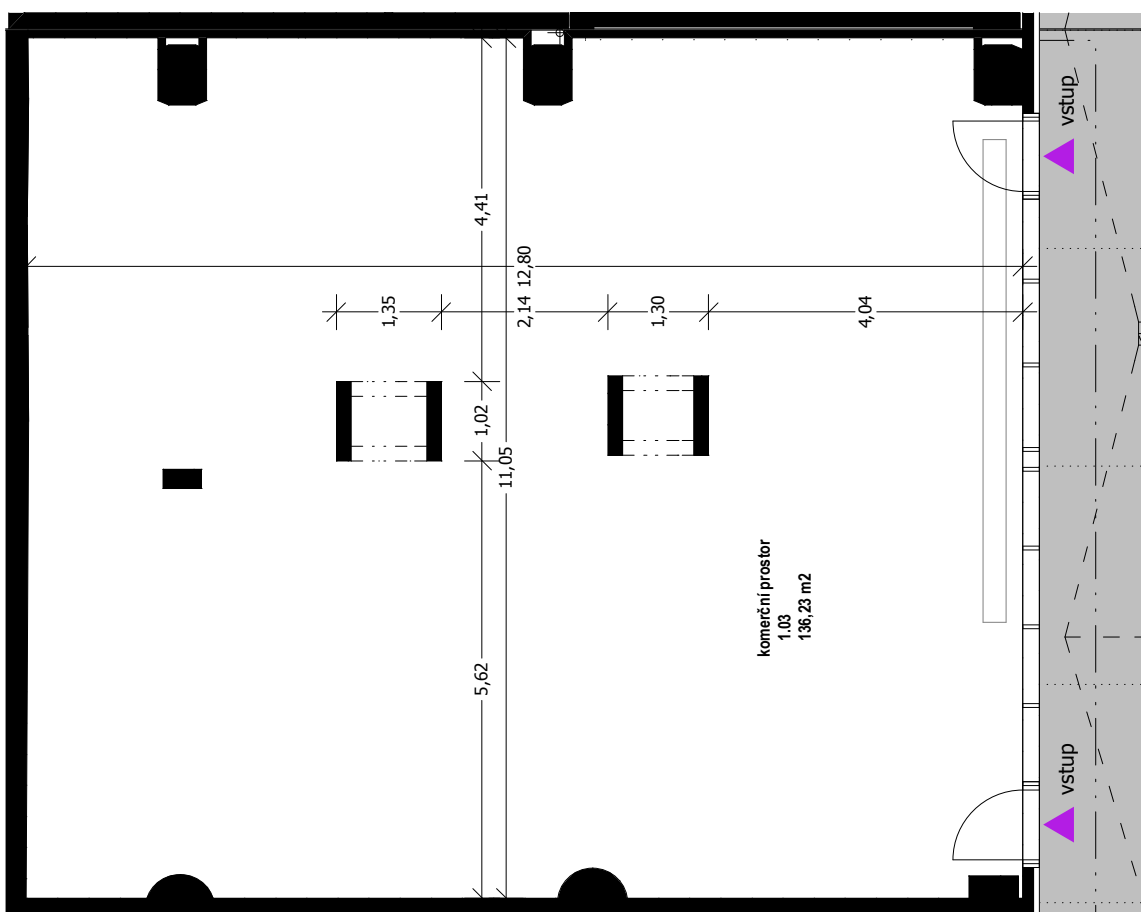
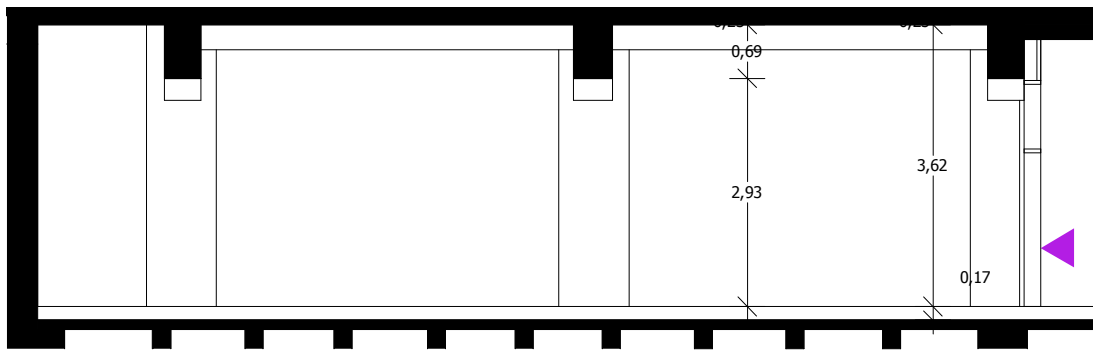

## 1. nadzemní podlaží

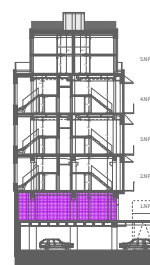

0 2 5  
1:100



typ: komerční prostor  
 orientace: východ  
 plocha: 136,23m<sup>2</sup>  
 terasa: -  
 garážové stání volitelně  
 sklep ne  
 jednotka:

Rezidence Lofts Krizikova

REZIDENCE LOFTS  
KRIZIKOVA

1.03

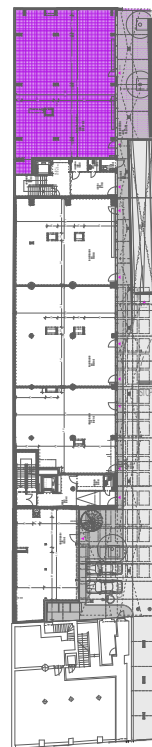
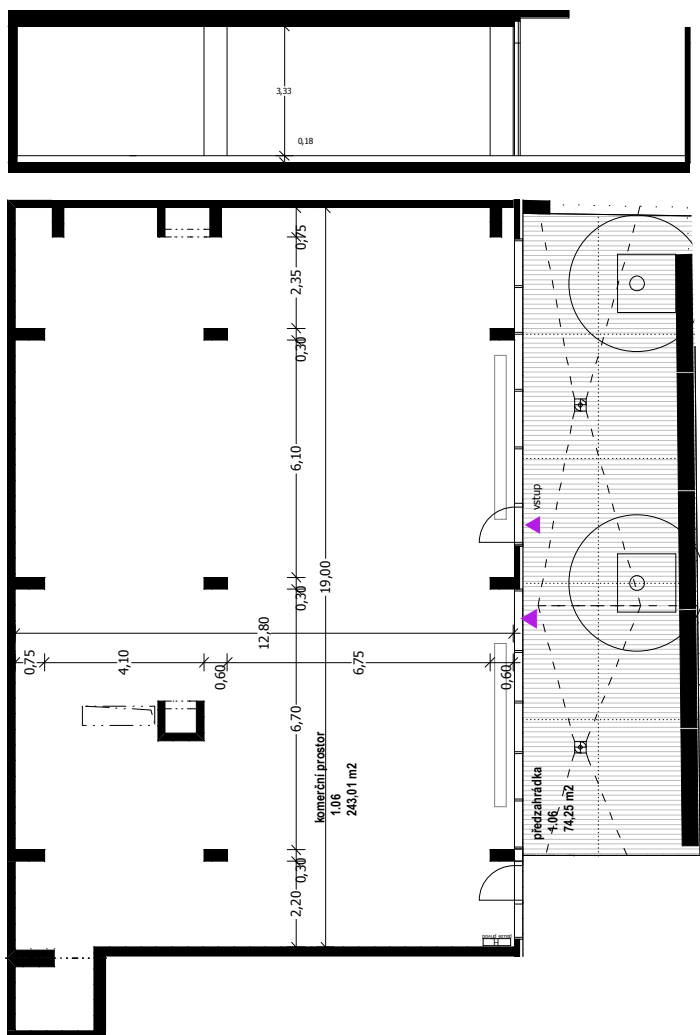

## 1. nadzemní podlaží

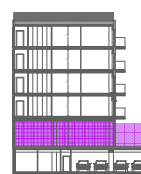

**typ:** komerční prostor  
**orientace:** východ  
**plocha:** 243,01m<sup>2</sup>  
**terasa:** 74,25m<sup>2</sup>  
**garážové stání** volitelně  
**sklep** ne  
**jednotka:**





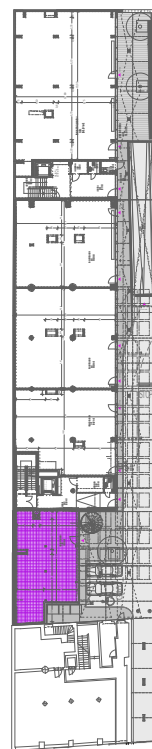
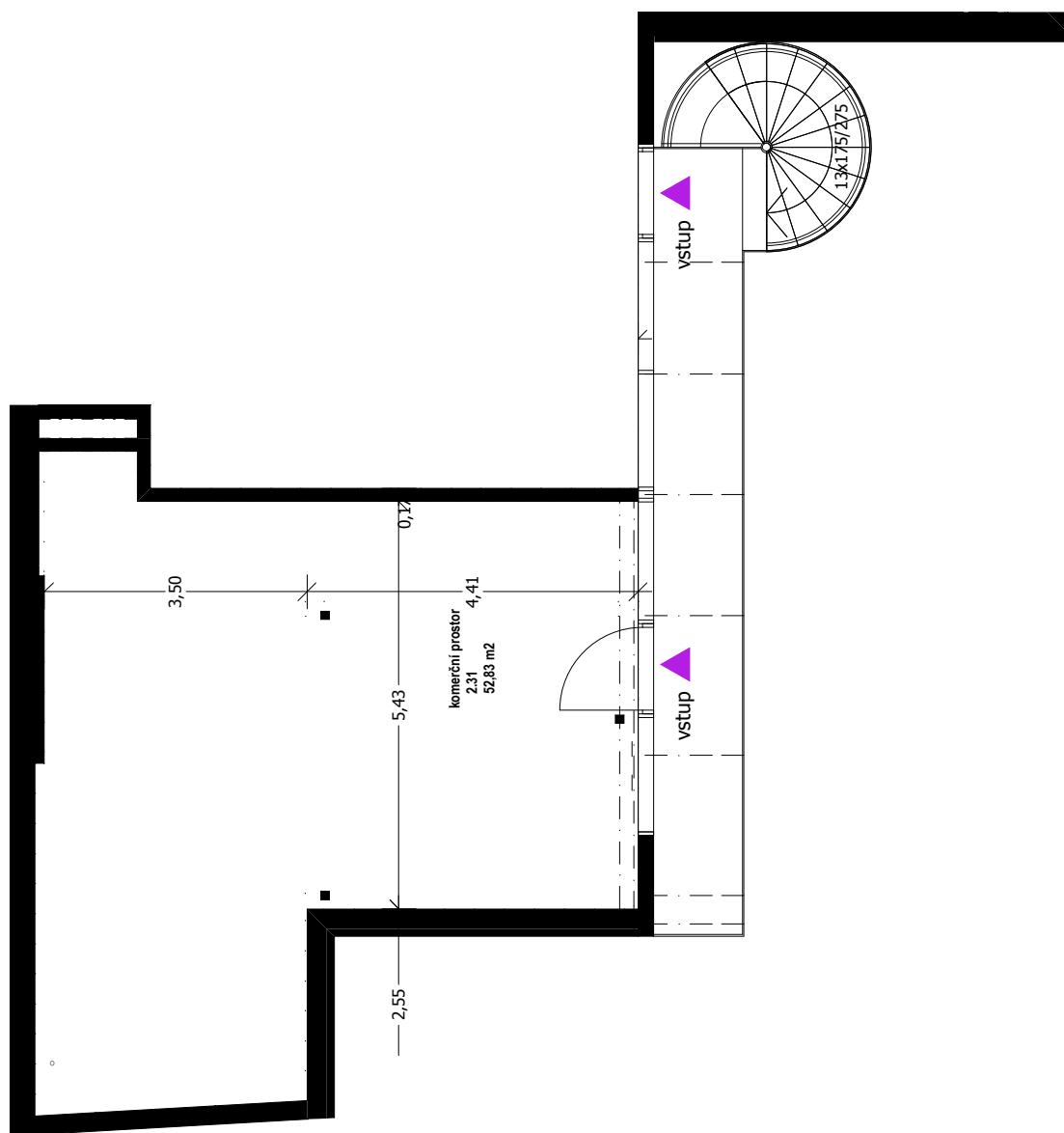
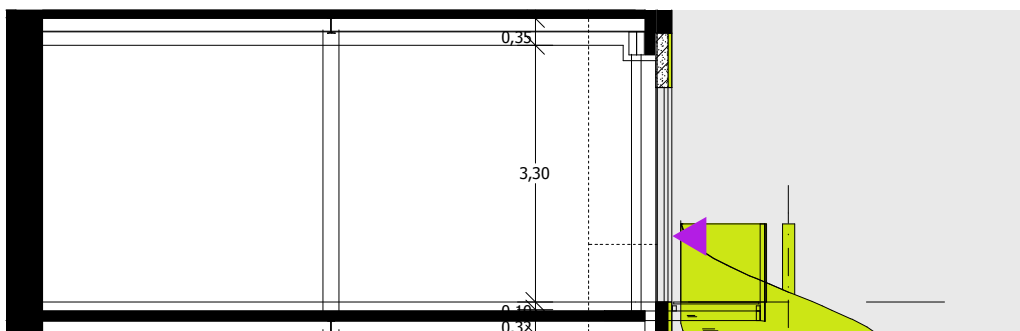

## 2. nadzemní podlaží

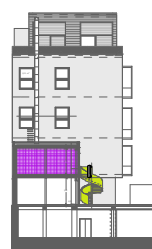

**typ:** komerční prostor  
**orientace:** východ  
**plocha:** 52,83m<sup>2</sup>  
**terasa:** -  
**garážové stání** volitelně  
**sklep** ne  
**jednotka:**



Rezidence Lofts Krizikova

REZIDENCE LOFTS  
KRIZIKOVA

2.31

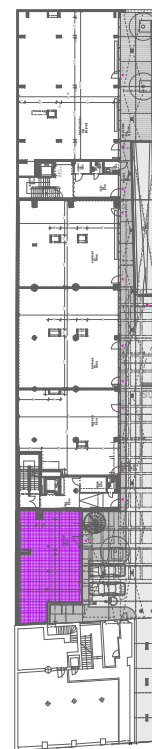
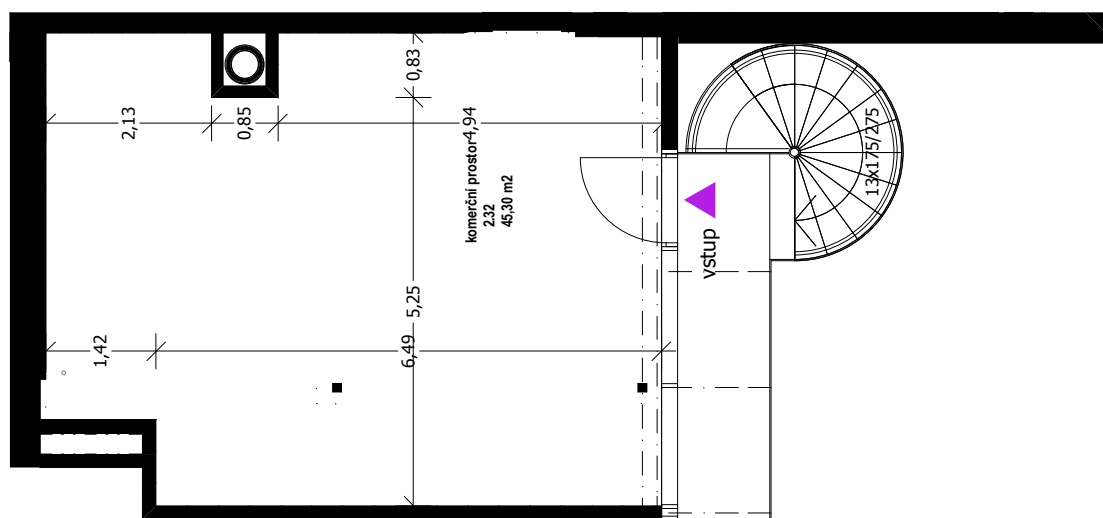
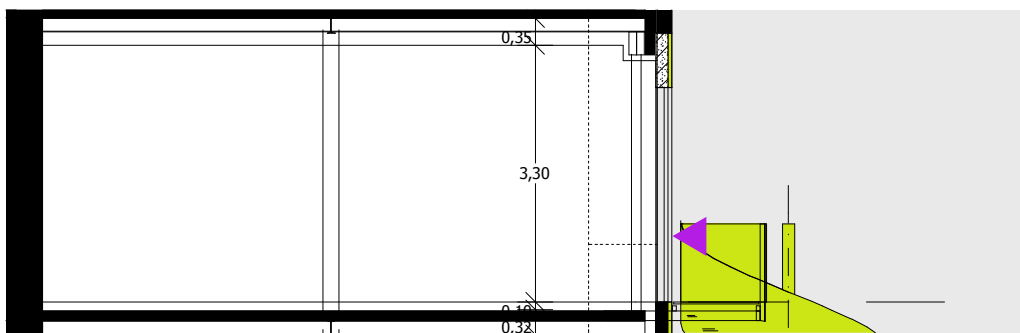

## 2. nadzemní podlaží

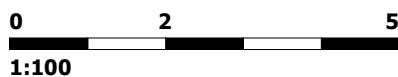
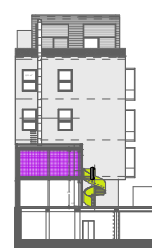

**typ:** komerční prostor  
**orientace:** východ  
**plocha:** 45,30m<sup>2</sup>  
**terasa:** -  
**garážové stání** volitelně  
**sklep** ne  
**jednotka:**

# katalog bytů



Residence Lofts Krizikova



CAPITAL TRUST, a.s.

tel: +420 602 649 490  
tel: +420 775 560 871

[martin.urman@cinzovnidomy.cz](mailto:martin.urman@cinzovnidomy.cz)  
[salesmanager@cinzovnidomy.cz](mailto:salesmanager@cinzovnidomy.cz)

[www.cinzovnidomy.cz](http://www.cinzovnidomy.cz)  
[www.loftskrizikova.eu](http://www.loftskrizikova.eu)



Residence Lofts Krizikova



vizualizace loftu

CAPITAL TRUST, a.s.

tel: +420 602 649 490  
tel: +420 775 560 871

[martin.urman@cinzovnidomy.cz](mailto:martin.urman@cinzovnidomy.cz)  
[salesmanager@cinzovnidomy.cz](mailto:salesmanager@cinzovnidomy.cz)

[www.cinzovnidomy.cz](http://www.cinzovnidomy.cz)  
[www.loftskrizikova.eu](http://www.loftskrizikova.eu)





Residence Lofts Krizikova



vizualizace bytu

CAPITAL TRUST, a.s.

tel: +420 602 649 490  
tel: +420 775 560 871

[martin.urman@cinzovnidomy.cz](mailto:martin.urman@cinzovnidomy.cz)  
[salesmanager@cinzovnidomy.cz](mailto:salesmanager@cinzovnidomy.cz)

[www.cinzovnidomy.cz](http://www.cinzovnidomy.cz)  
[www.loftskrizikova.eu](http://www.loftskrizikova.eu)



Residence Lofts Krizikova



vizualizace mezonetu

CAPITAL TRUST, a.s.

tel: +420 602 649 490  
tel: +420 775 560 871

[martin.urman@cinzovnidomy.cz](mailto:martin.urman@cinzovnidomy.cz)  
[salesmanager@cinzovnidomy.cz](mailto:salesmanager@cinzovnidomy.cz)

[www.cinzovnidomy.cz](http://www.cinzovnidomy.cz)  
[www.loftskrizikova.eu](http://www.loftskrizikova.eu)

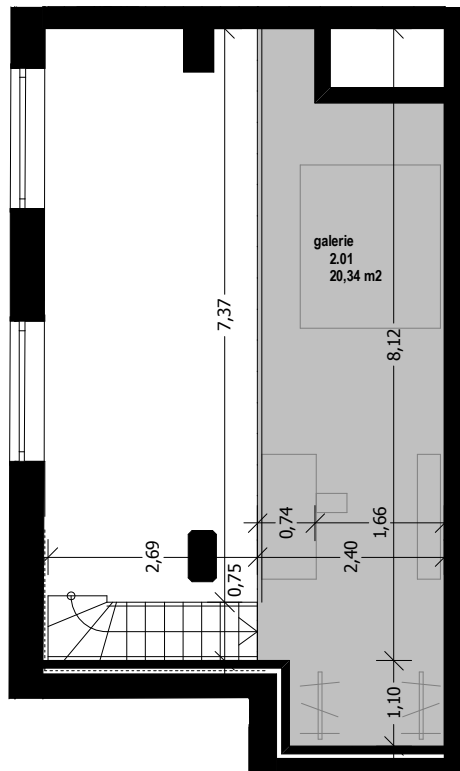
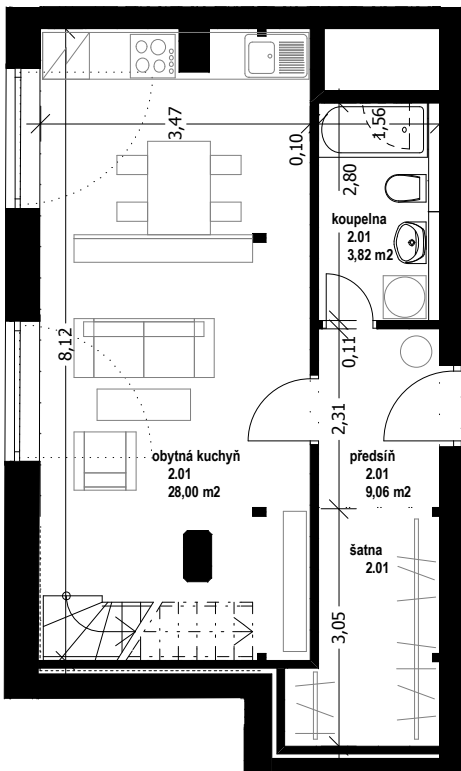
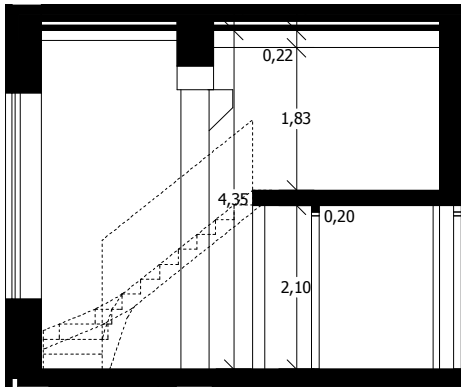

## 2. nadzemní podlaží

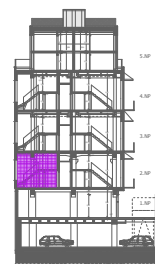

typ bytu:	1+kk loft
orientace:	západ
spodní patro:	40,88m <sup>2</sup>
galerie:	20,34m <sup>2</sup>
balkon:	-
terasa:	-
garážové stání	-
sklep	-

0 2 5  
1:100



Rezidence Lofts Krizikova

REZIDENCE LOFTS  
KRIZIKOVA

CAPITAL TRUST, a.s.

tel: +420 602 649 490  
tel: +420 775 560 871

martin.urman@cinzovnidomy.cz  
salesmanager@cinzovnidomy.cz

www.cinzovnidomy.cz  
www.loftskrizikova.eu

**byt: 2.01**

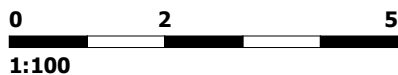
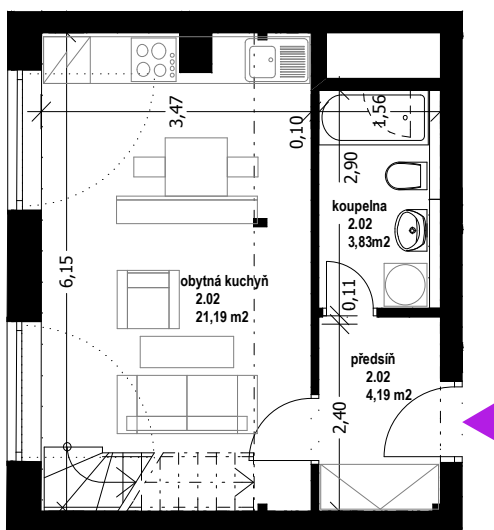
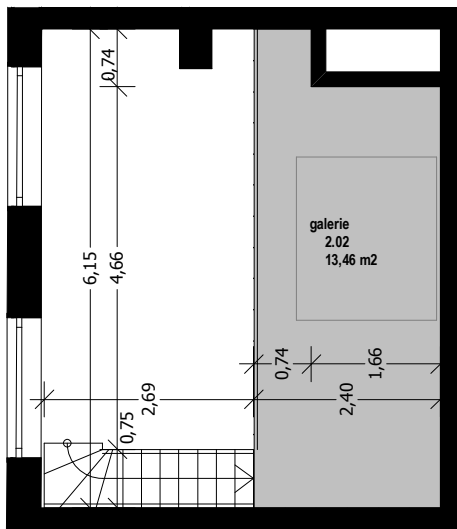
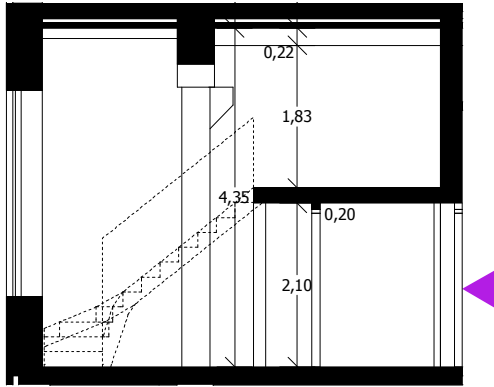

## 2. nadzemní podlaží

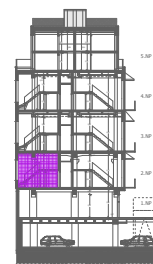

typ bytu:	1+kk loft
orientace:	západ
spodní patro:	29,21m <sup>2</sup>
galerie:	13,46m <sup>2</sup>
balkon:	-
terasa:	-
garážové stání	-
sklep	-

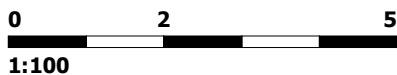
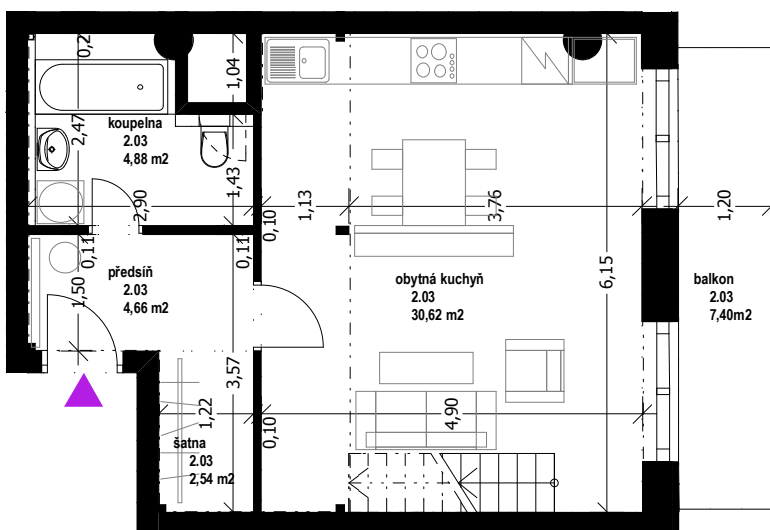
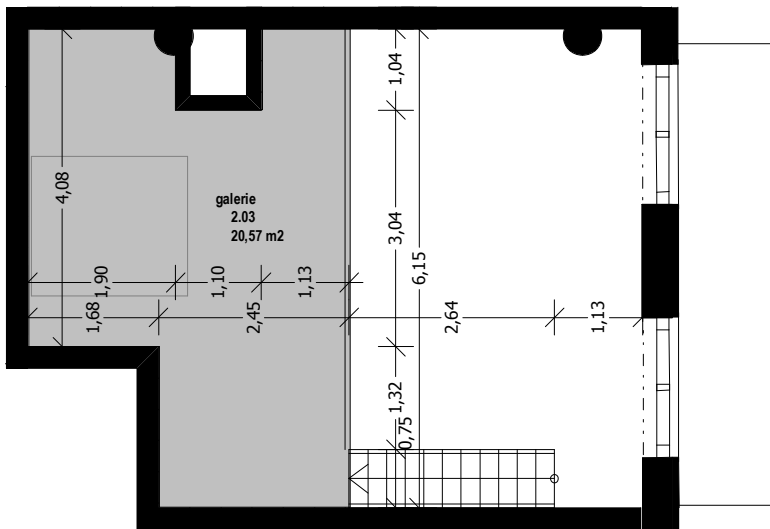
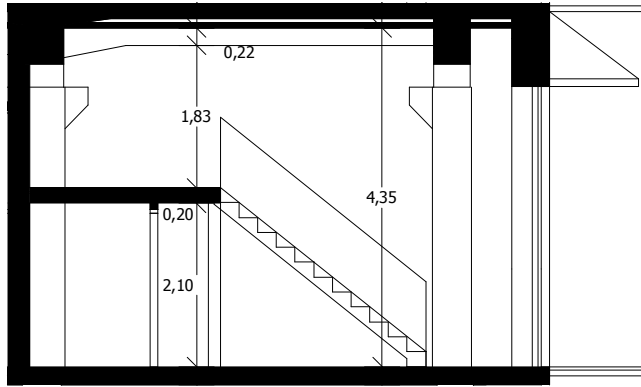

## 2. nadzemní podlaží

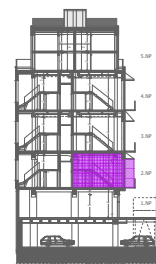

typ bytu:	1+kk loft
orientace:	východ
spodní patro:	42,70m <sup>2</sup>
galerie:	20,57m <sup>2</sup>
balkon:	7,40m <sup>2</sup>
terasa:	-
garážové stání	-
sklep	-

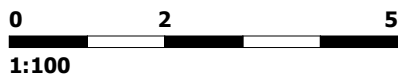
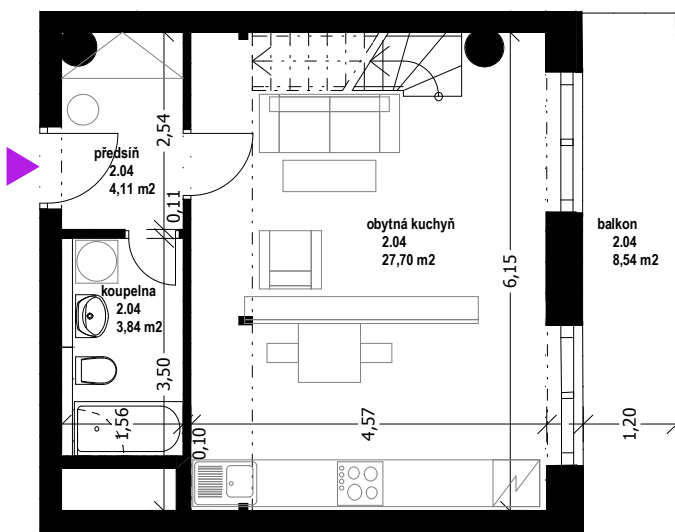
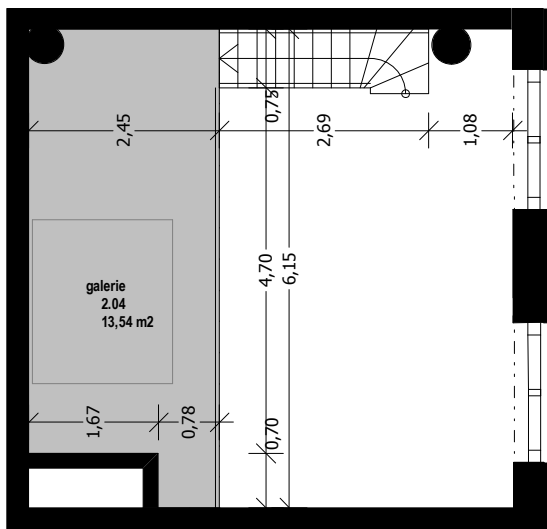
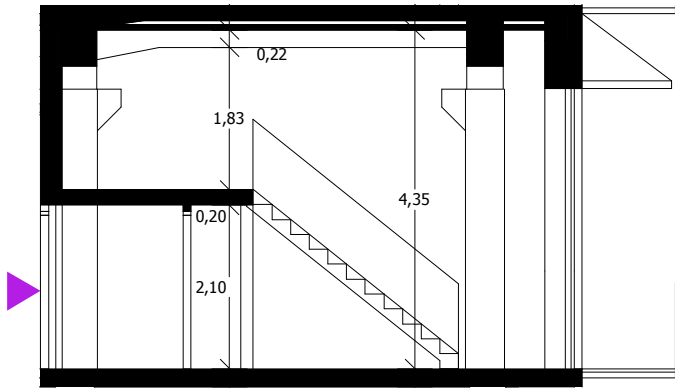

## 2. nadzemní podlaží

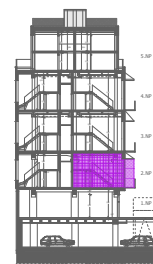

typ bytu:	1+kk loft
orientace:	východ
spodní patro:	35,64m <sup>2</sup>
galerie:	13,54m <sup>2</sup>
balkon:	8,54m <sup>2</sup>
terasa:	-
garážové stání	-
sklep	-



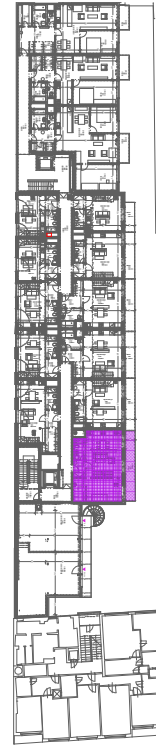
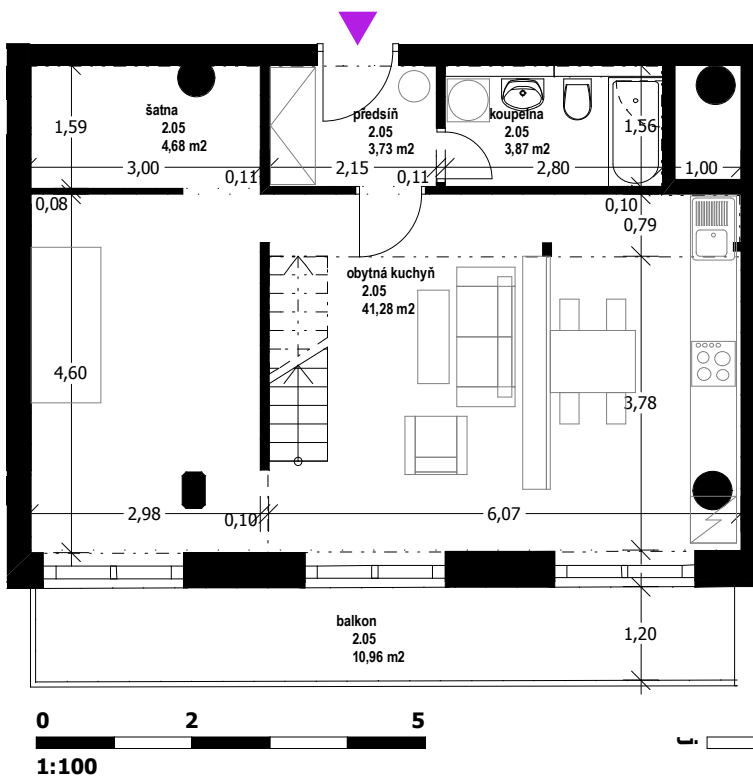
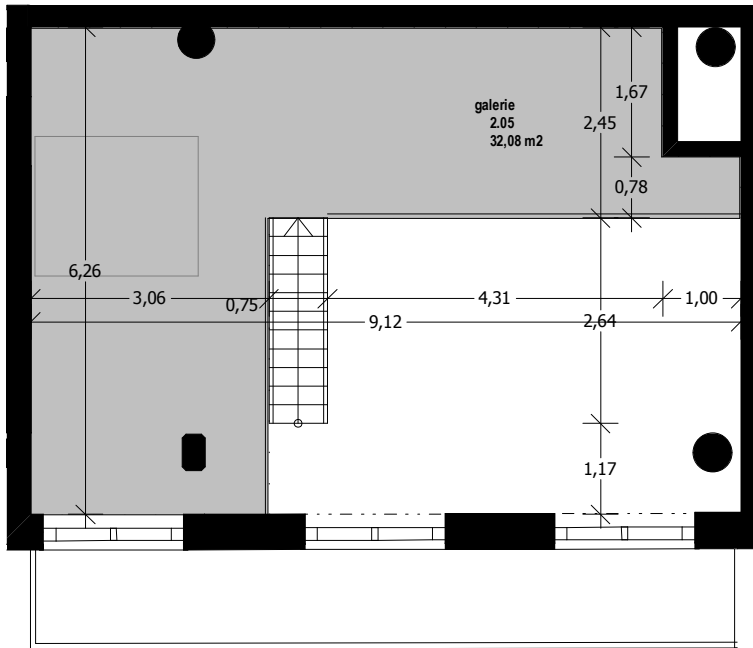
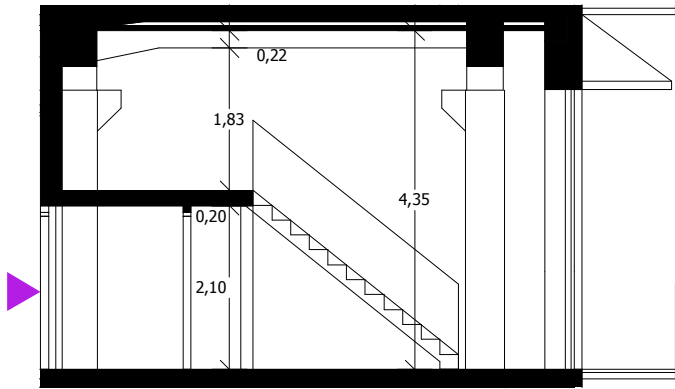

## 2. nadzemní podlaží

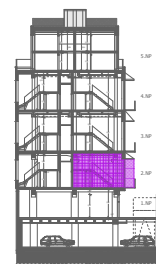

typ bytu:	1+kk loft
orientace:	východ
spodní patro:	53,55m <sup>2</sup>
galerie:	32,08m <sup>2</sup>
balkon:	10,96m <sup>2</sup>
terasa:	-
garážové stání	-
sklep	-

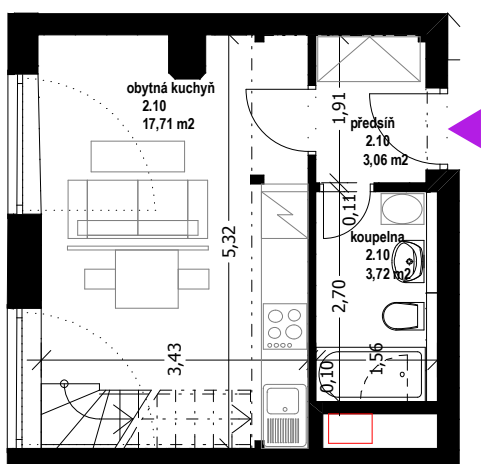
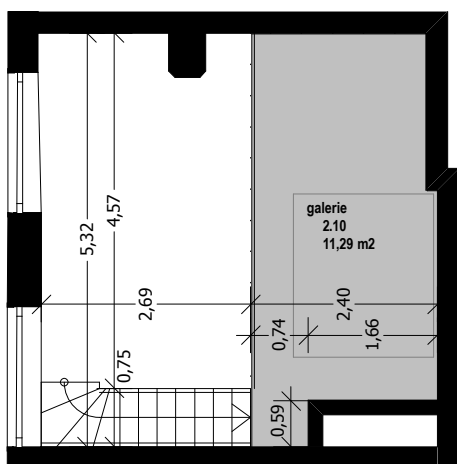
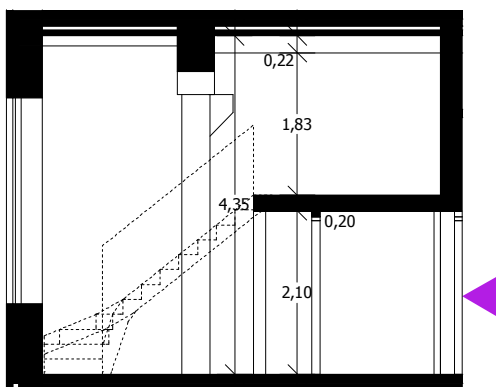

0 2 5  
1:100

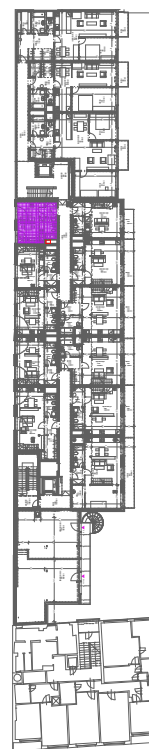

## 2. nadzemní podlaží

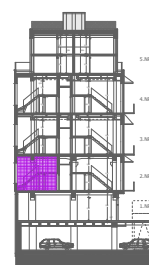

typ bytu:	1+kk loft
orientace:	západ
spodní patro:	24,49m <sup>2</sup>
galerie:	11,29m <sup>2</sup>
balkon:	-
terasa:	-
garážové stání	-
sklep	-





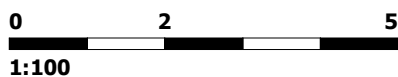
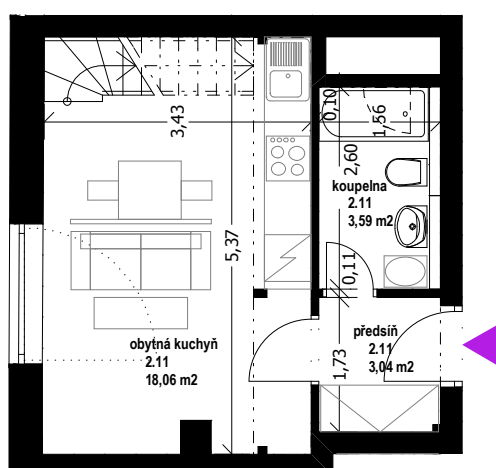
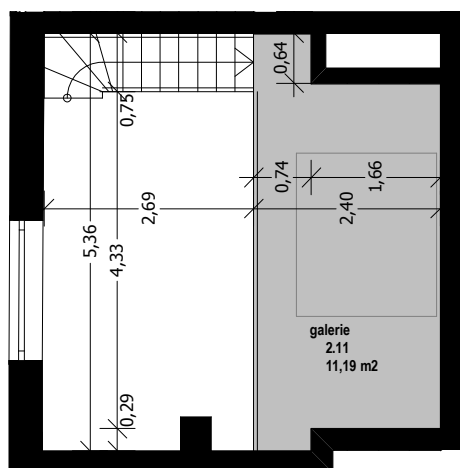
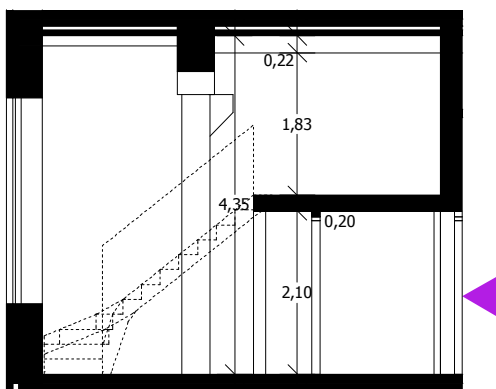

## 2. nadzemní podlaží

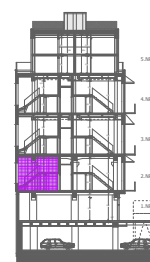

typ bytu:	1+kk loft
orientace:	západ
spodní patro:	24,69m <sup>2</sup>
galerie:	11,19m <sup>2</sup>
balkon:	-
terasa:	-
garážové stání	-
sklep	-

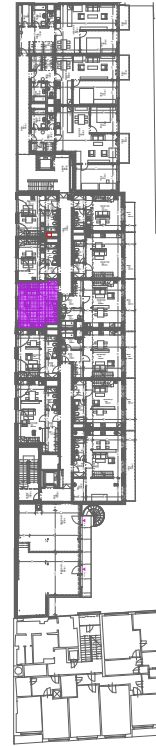
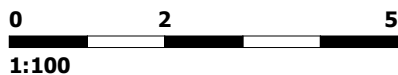
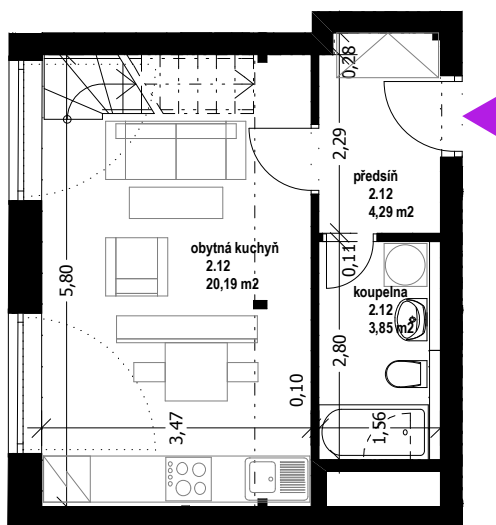
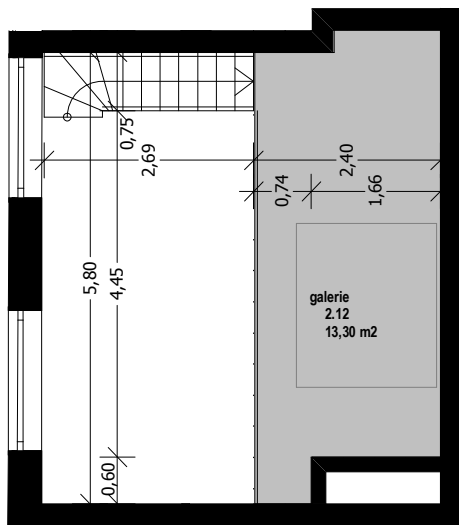
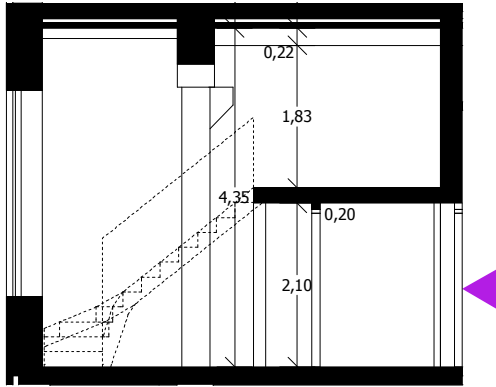

## 2. nadzemní podlaží

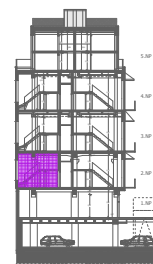

typ bytu:	1+kk loft
orientace:	západ
spodní patro:	28,33m <sup>2</sup>
galerie:	13,30m <sup>2</sup>
balkon:	-
terasa:	-
garážové stání	-
sklep	-

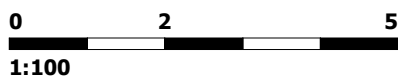
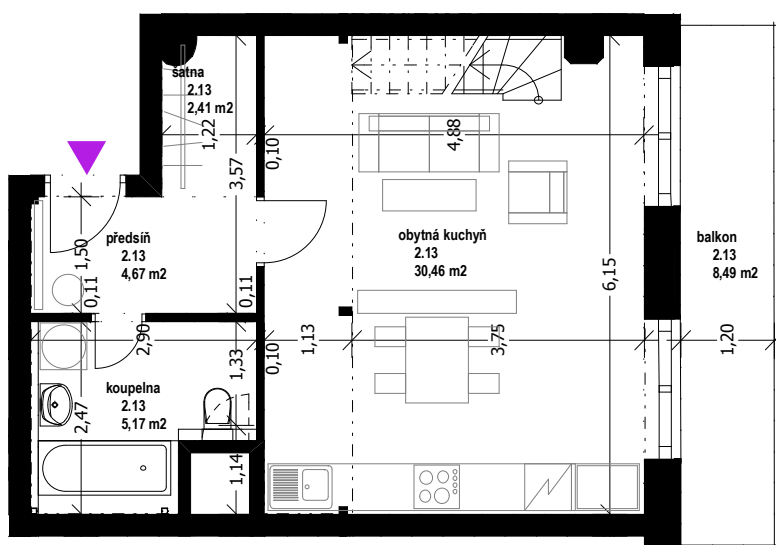
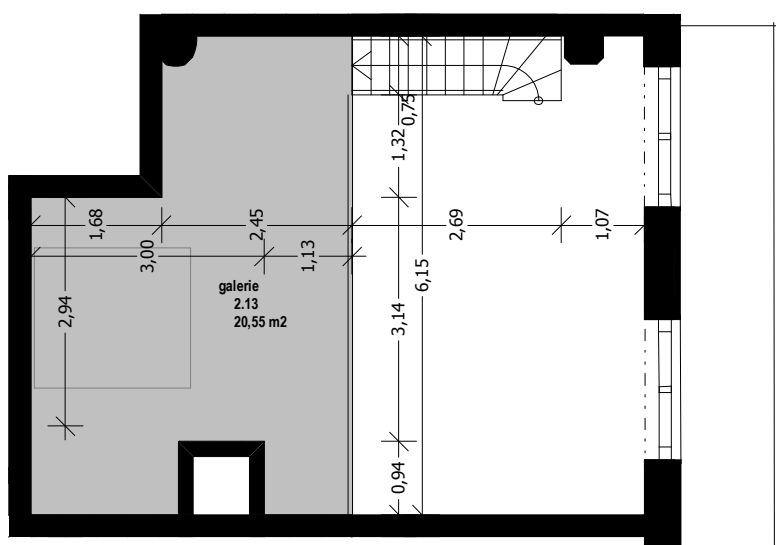
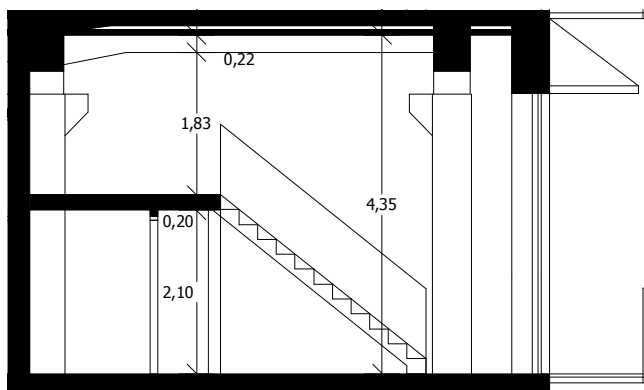

## 2. nadzemní podlaží

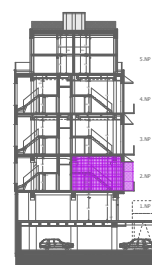

typ bytu:	1+kk loft
orientace:	východ
spodní patro:	42,71m <sup>2</sup>
galerie:	20,55m <sup>2</sup>
balkon:	8,49m <sup>2</sup>
terasa:	-
garážové stání	-
sklep	-

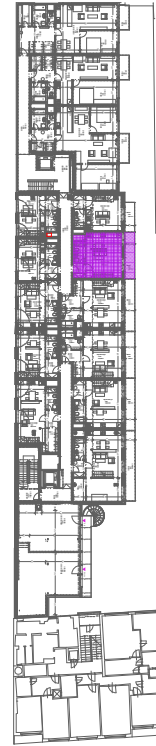
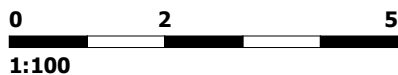
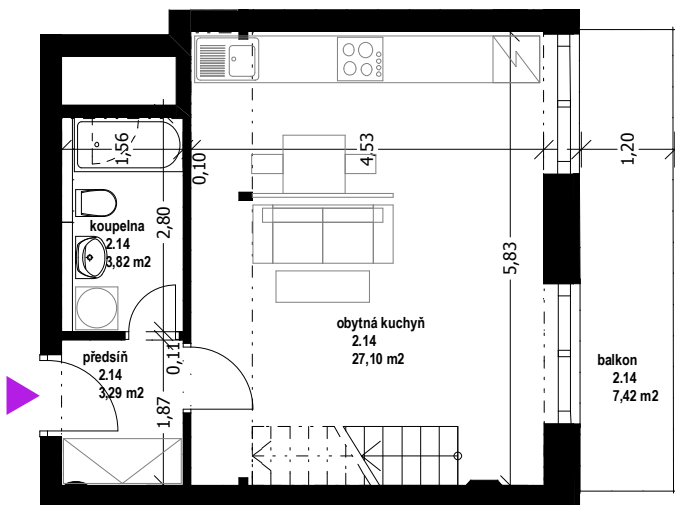
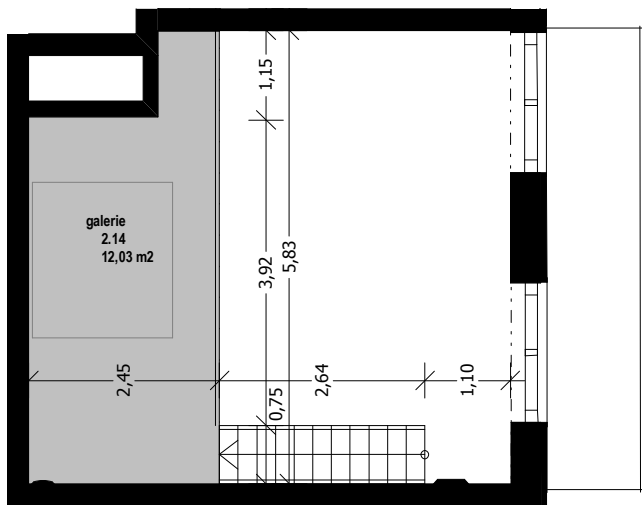
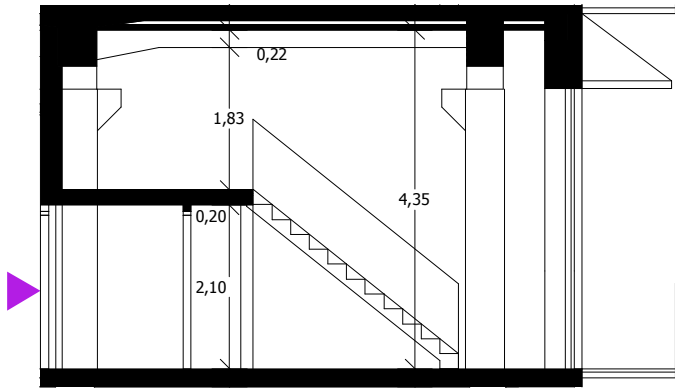

## 2. nadzemní podlaží

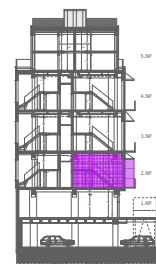

typ bytu:	1+kk loft
orientace:	východ
spodní patro:	34,21m <sup>2</sup>
galerie:	12,03m <sup>2</sup>
balkon:	7,42m <sup>2</sup>
terasa:	-
garážové stání	-
sklep	-

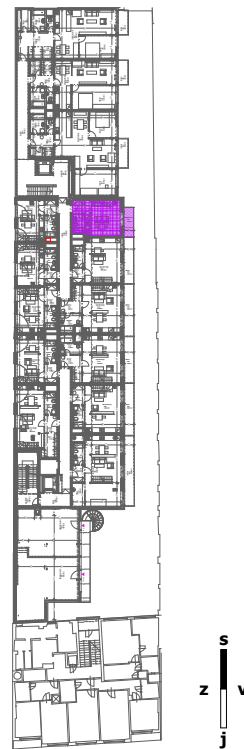
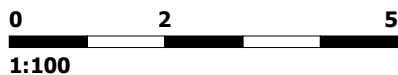
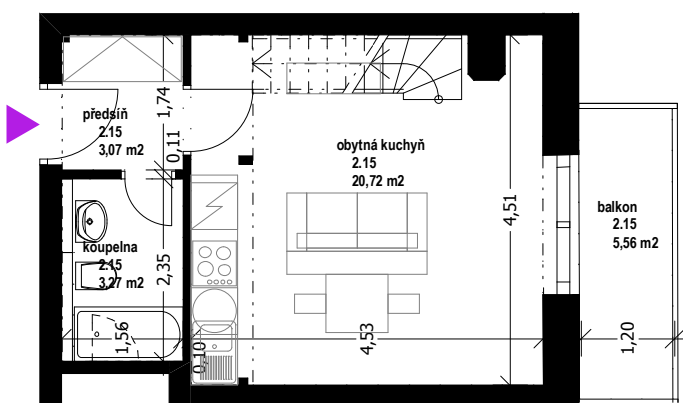
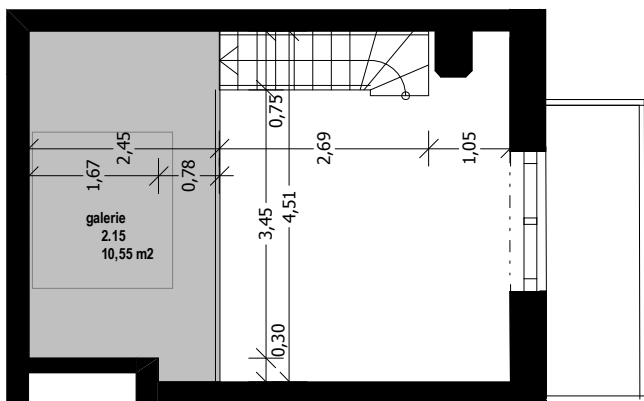
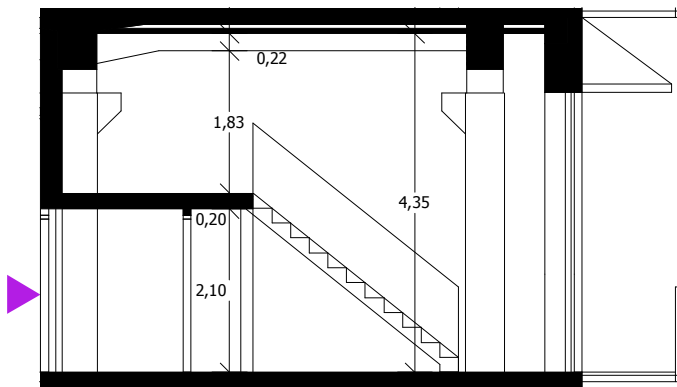

## 2. nadzemní podlaží

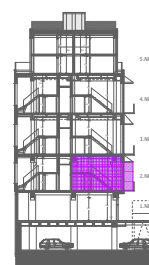

typ bytu:	1+kk loft
orientace:	východ
spodní patro:	27,06m <sup>2</sup>
galerie:	10,55m <sup>2</sup>
balkon:	5,56m <sup>2</sup>
terasa:	-
garážové stání	-
sklep	-

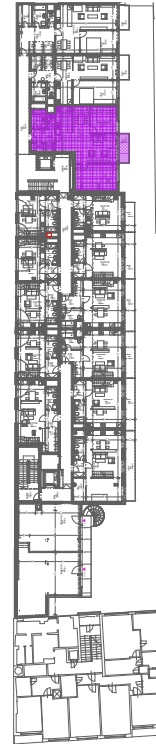
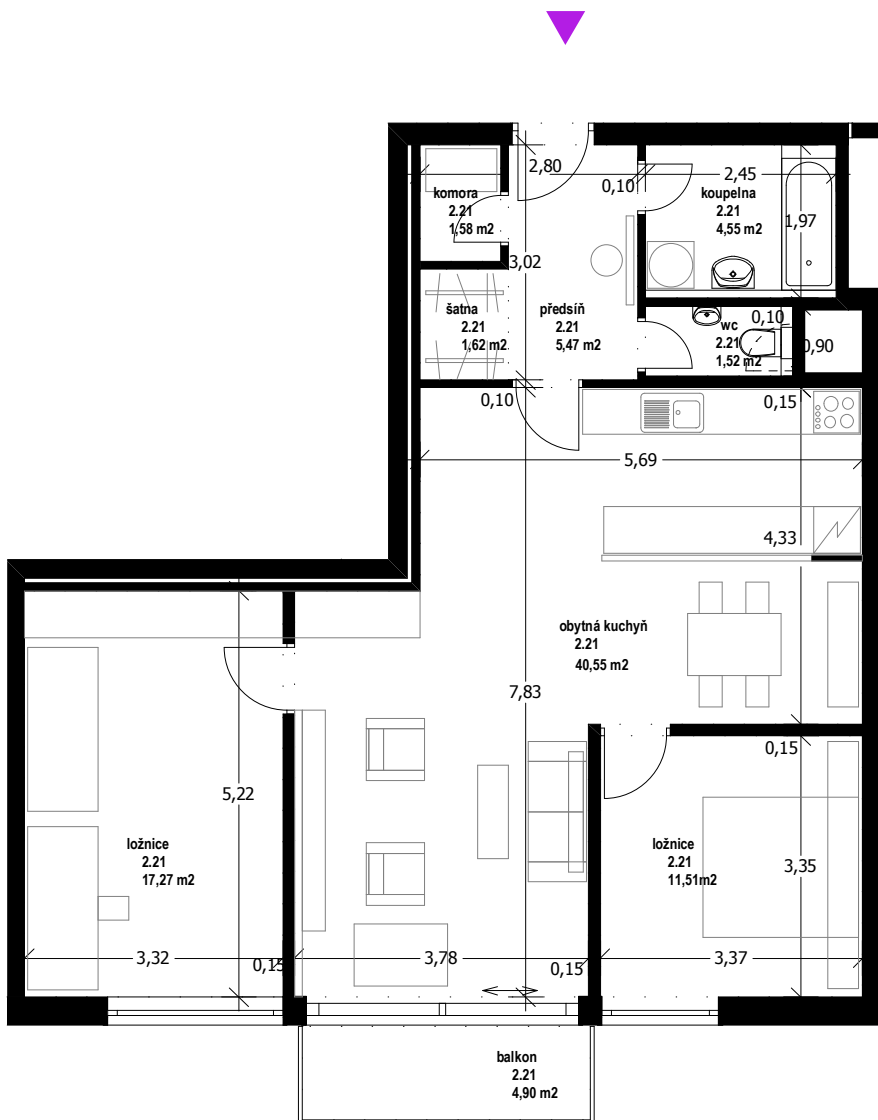

## 2. nadzemní podlaží



typ bytu:	3+kk
orientace:	východ
spodní patro:	84,06m <sup>2</sup>
galerie:	-
balkon:	4,90m <sup>2</sup>
terasa:	-
garážové stání	-
sklep	-

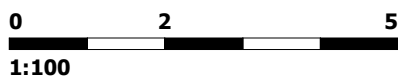

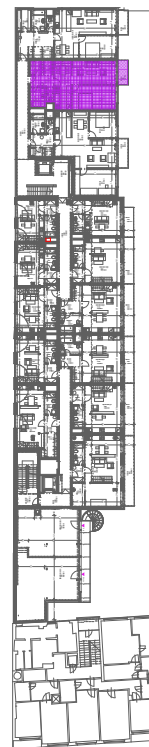
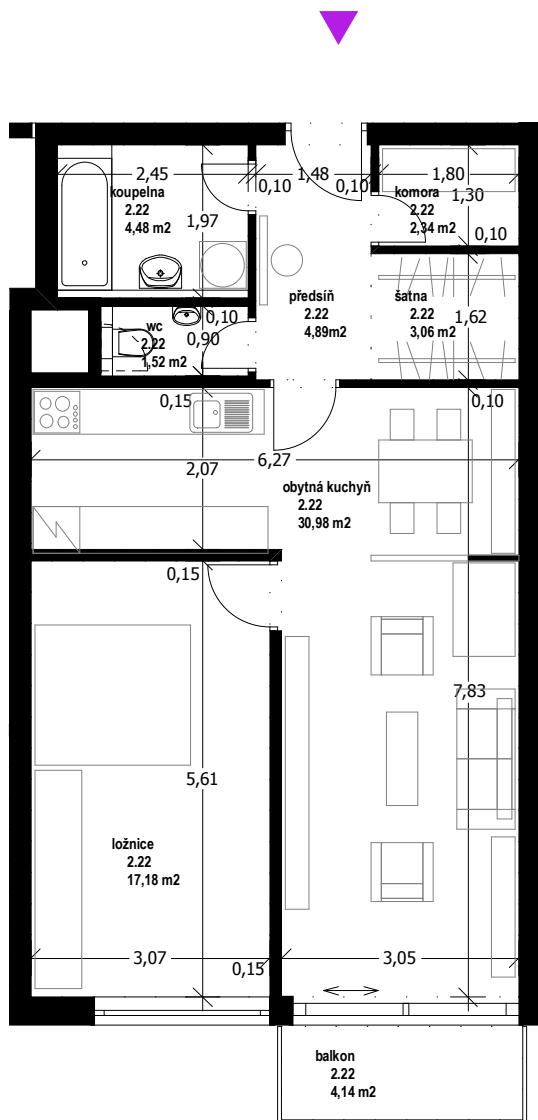

## 2. nadzemní podlaží

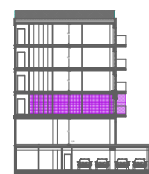

typ bytu:	2+kk
orientace:	východ
spodní patro:	64,47m <sup>2</sup>
galerie:	-
balkon:	4,14m <sup>2</sup>
terasa:	-
garážové stání	-
sklep	-

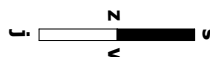
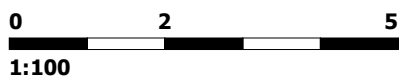

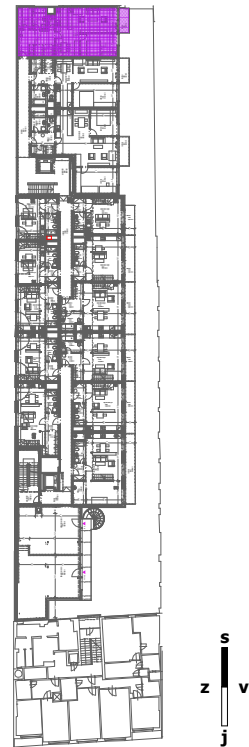
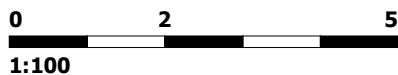
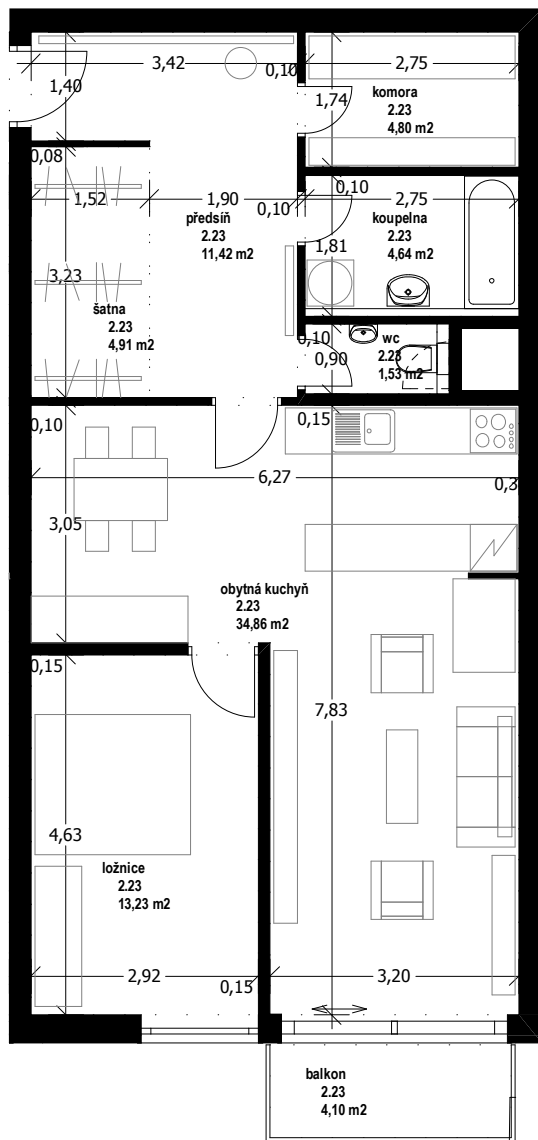

## 2. nadzemní podlaží

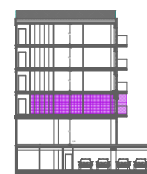

typ bytu:	2+kk
orientace:	východ
spodní patro:	75,38m <sup>2</sup>
galerie:	-
balkon:	4,10m <sup>2</sup>
terasa:	-
garážové stání	-
sklep	-



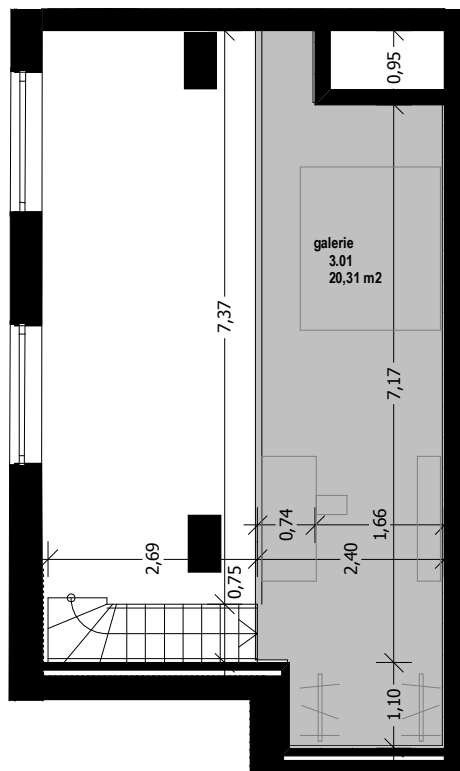
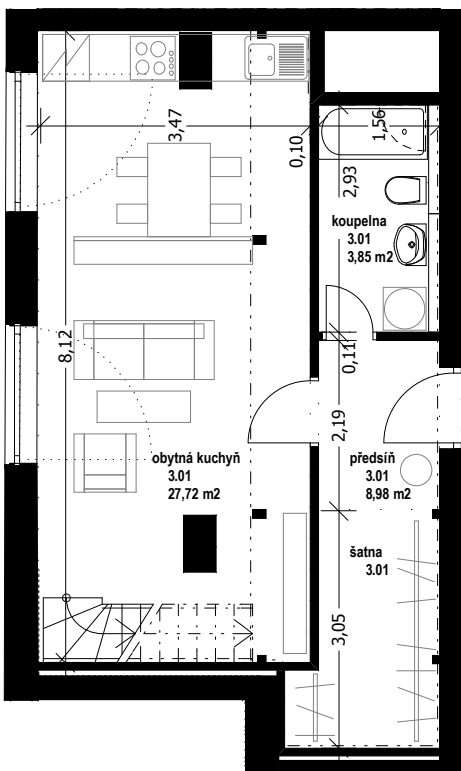
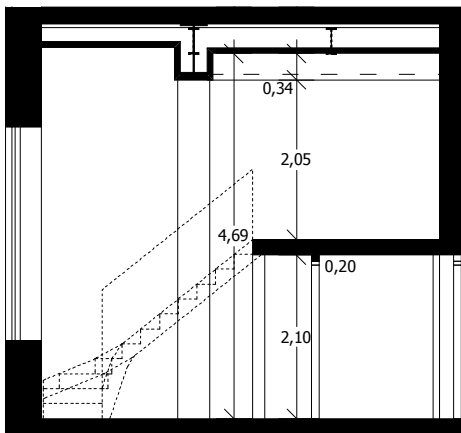

### 3. nadzemní podlaží

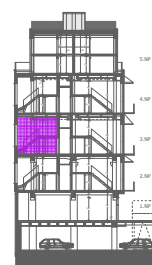

typ bytu:	1+kk loft
orientace:	západ
spodní patro:	40,55m <sup>2</sup>
galerie:	20,31m <sup>2</sup>
balkon:	-
terasa:	-
garážové stání	-
sklep	-

0 2 5  
1:100



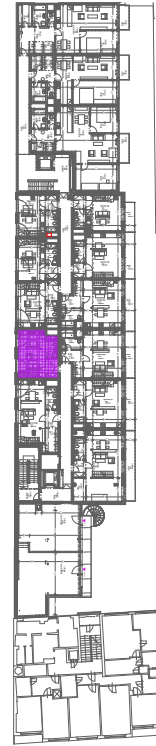
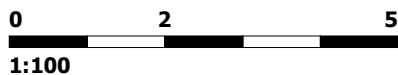
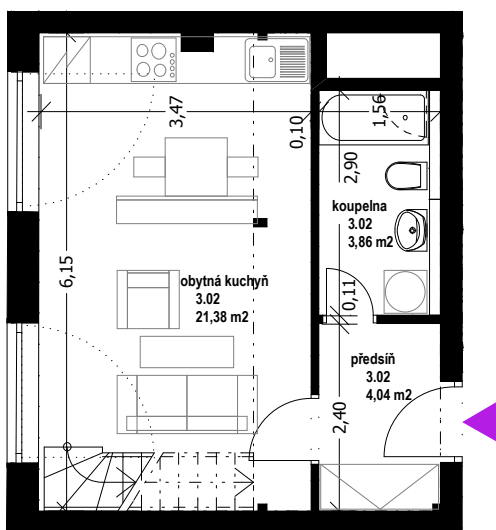
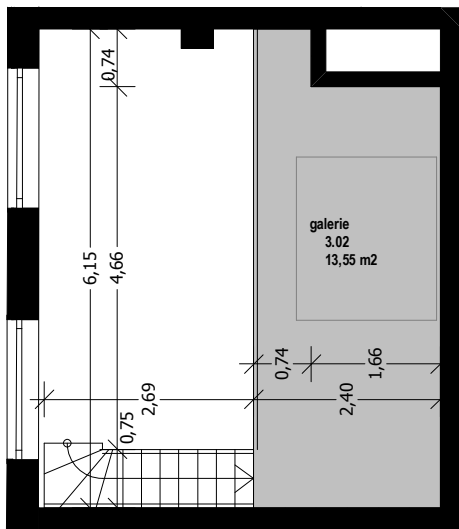
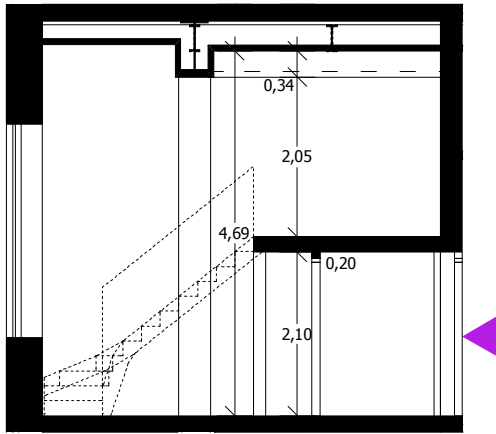

### 3. nadzemní podlaží

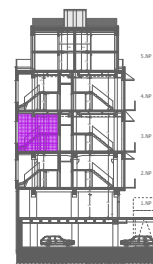

<b>typ bytu:</b>	<b>1+kk loft</b>
<b>orientace:</b>	<b>západ</b>
<b>spodní patro:</b>	<b>29,28m<sup>2</sup></b>
<b>galerie:</b>	<b>13,55m<sup>2</sup></b>
<b>balkon:</b>	-
<b>terasa:</b>	-
<b>garážové stání</b>	-
<b>sklep</b>	-

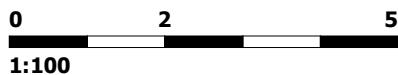
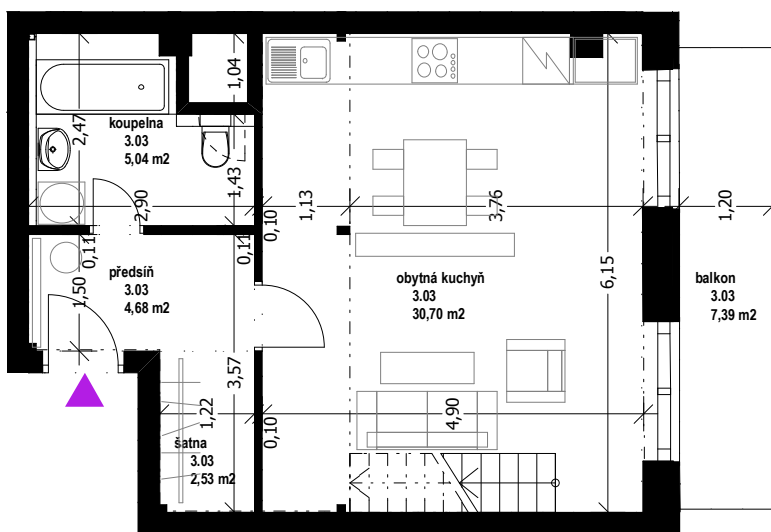
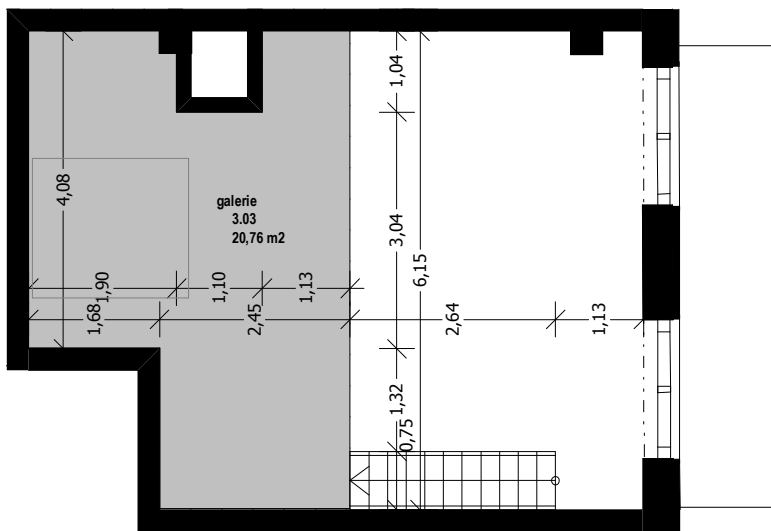
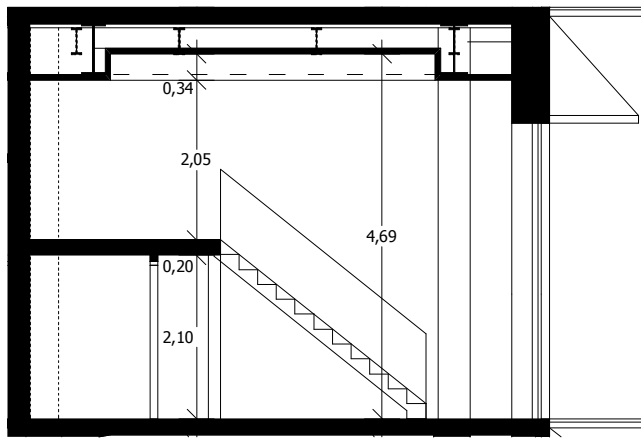

### 3. nadzemní podlaží

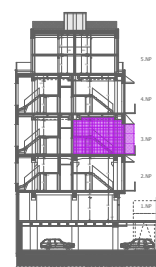

<b>typ bytu:</b>	<b>1+kk loft</b>
<b>orientace:</b>	<b>východ</b>
<b>spodní patro:</b>	<b>42,95m<sup>2</sup></b>
<b>galerie:</b>	<b>20,76m<sup>2</sup></b>
<b>balkon:</b>	<b>7,39m<sup>2</sup></b>
<b>terasa:</b>	-
<b>garážové stání</b>	-
<b>sklep</b>	-

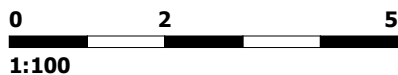
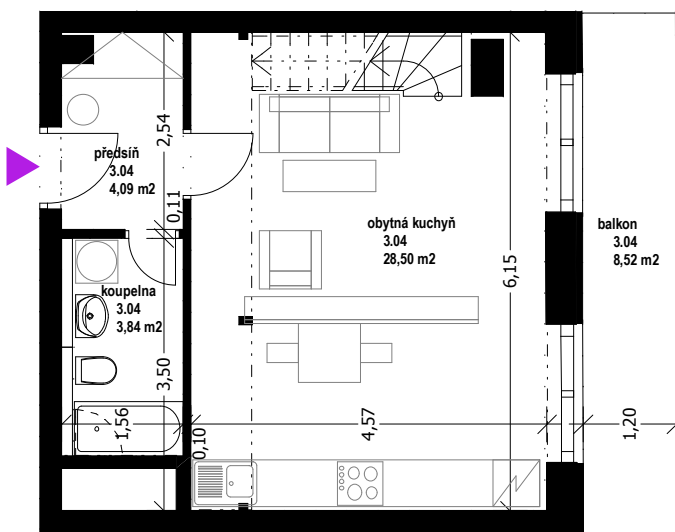
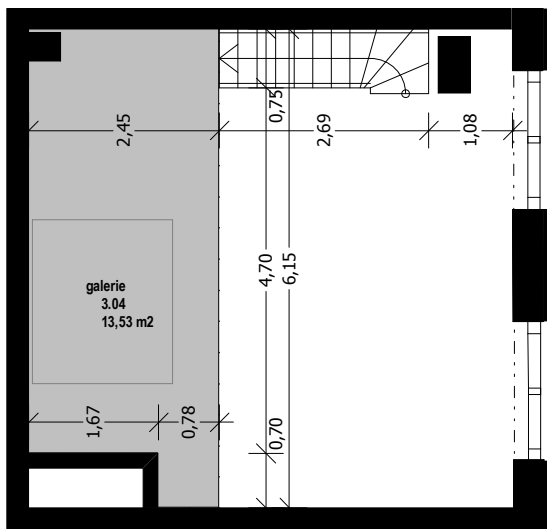
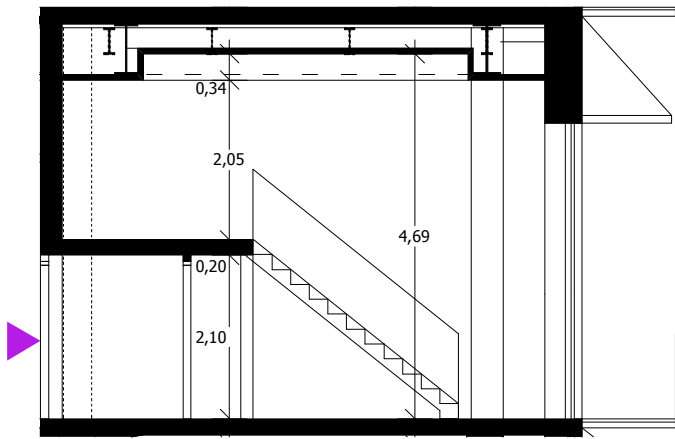

### 3. nadzemní podlaží

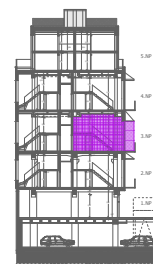

<b>typ bytu:</b>	<b>1+kk loft</b>
<b>orientace:</b>	<b>východ</b>
<b>spodní patro:</b>	<b>36,42m<sup>2</sup></b>
<b>galerie:</b>	<b>13,53m<sup>2</sup></b>
<b>balkon:</b>	<b>8,52m<sup>2</sup></b>
<b>terasa:</b>	-
<b>garážové stání</b>	-
<b>sklep</b>	-

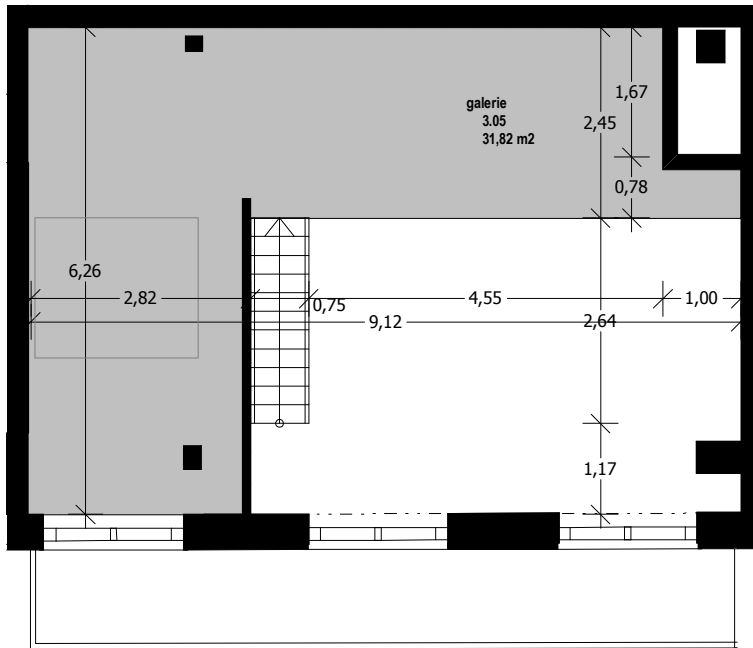
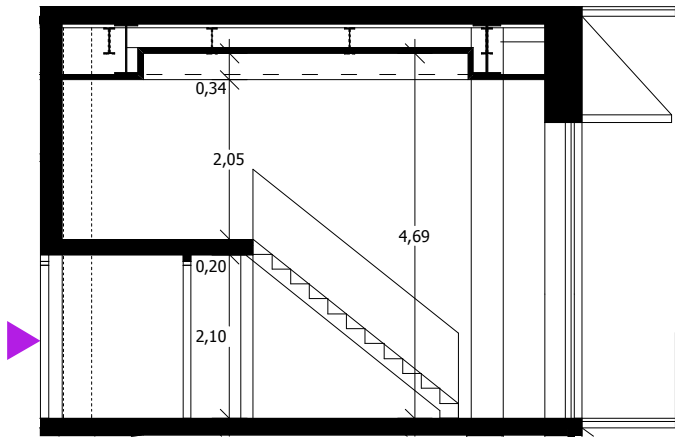

### 3. nadzemní podlaží

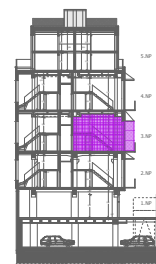

typ bytu:	1+kk loft
orientace:	východ
spodní patro:	56,22m <sup>2</sup>
galerie:	31,82m <sup>2</sup>
balkon:	10,82m <sup>2</sup>
terasa:	-
garážové stání	-
sklep	-

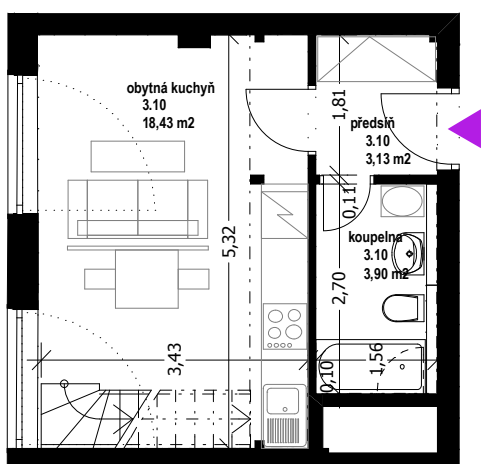
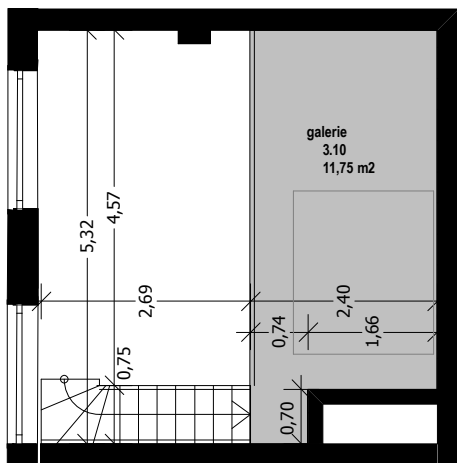
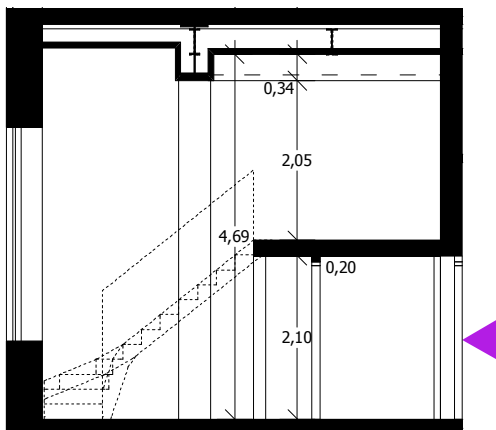

0 2 5  
1:100

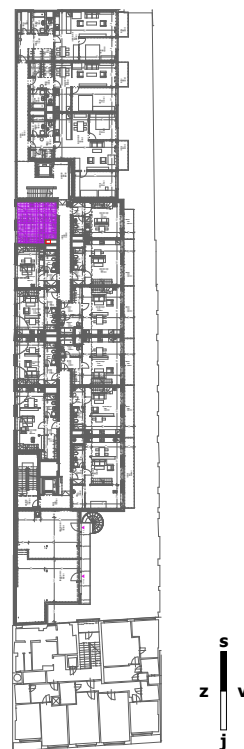

### 3. nadzemní podlaží

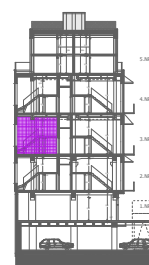

typ bytu:	1+kk loft
orientace:	západ
spodní patro:	25,45m <sup>2</sup>
galerie:	11,75m <sup>2</sup>
balkon:	-
terasa:	-
garážové stání	-
sklep	-



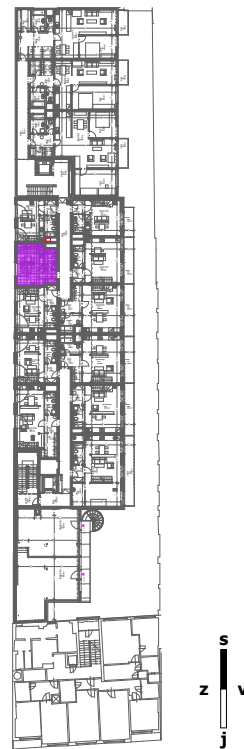
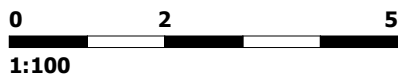
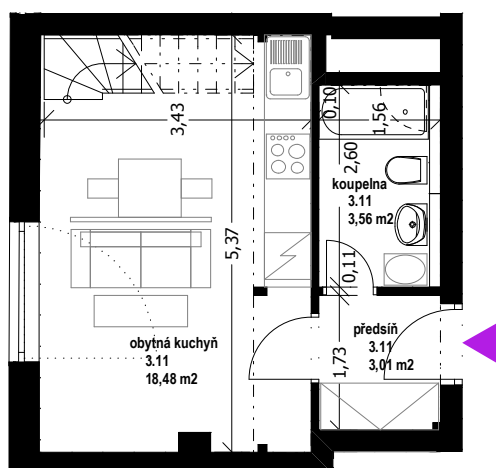
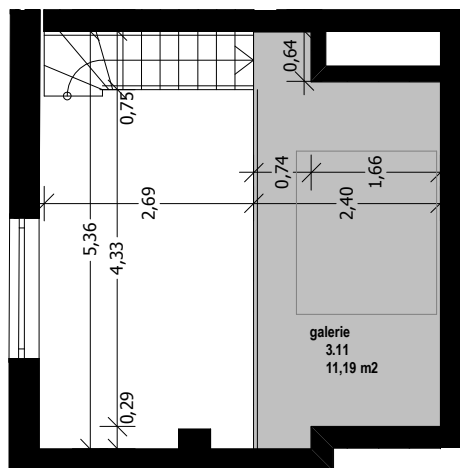
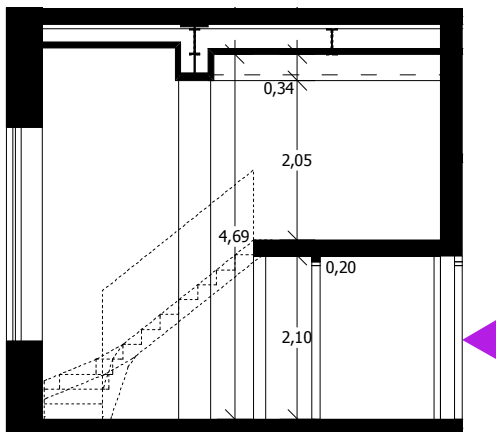

### 3. nadzemní podlaží

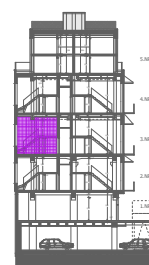

typ bytu:	1+kk loft
orientace:	západ
spodní patro:	25,04m <sup>2</sup>
galerie:	11,19m <sup>2</sup>
balkon:	-
terasa:	-
garážové stání	-
sklep	-

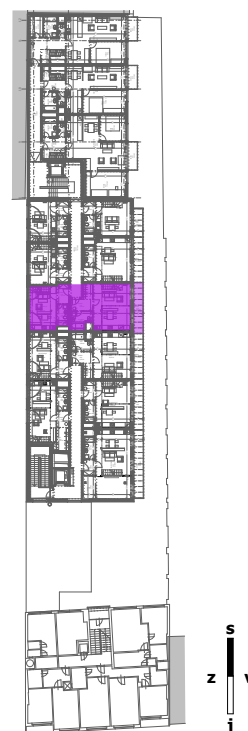

### 3. nadzemní podlaží

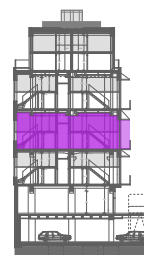

typ bytu:	6+kk loft
orientace:	západ, východ
spodní patro:	76,80 m <sup>2</sup>
galerie:	66,00 m <sup>2</sup>
balkon:	8,02m <sup>2</sup>
terasa:	-
garážové stání	-
sklep	-



**Rezidence Lofts Krizikova**

REZIDENCE LOFTS  
KRIZIKOVA

**byt: 3.12**





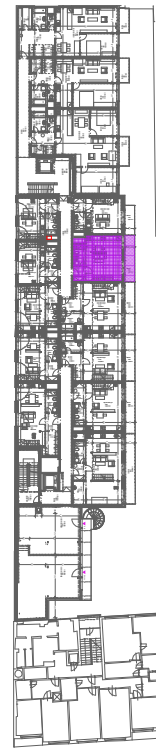
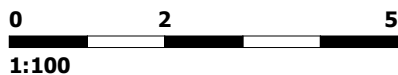
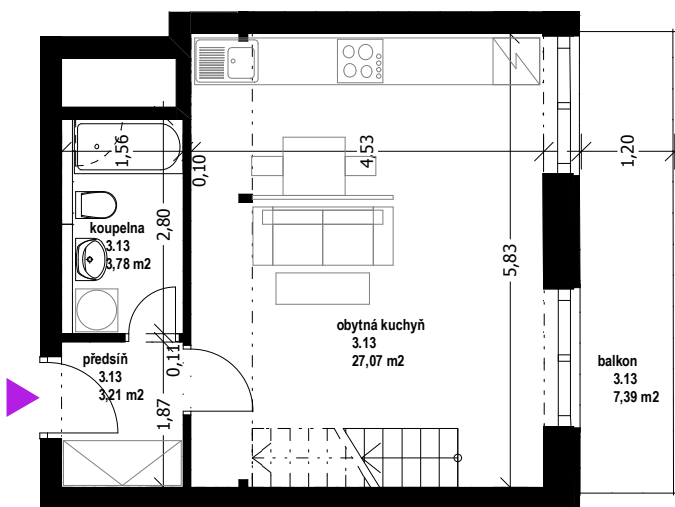
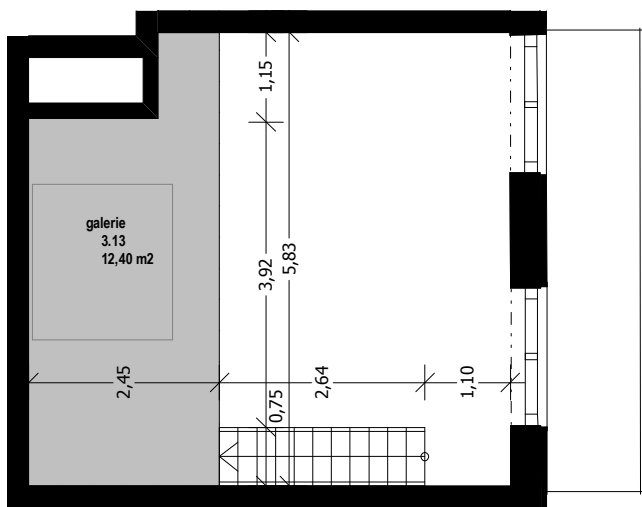
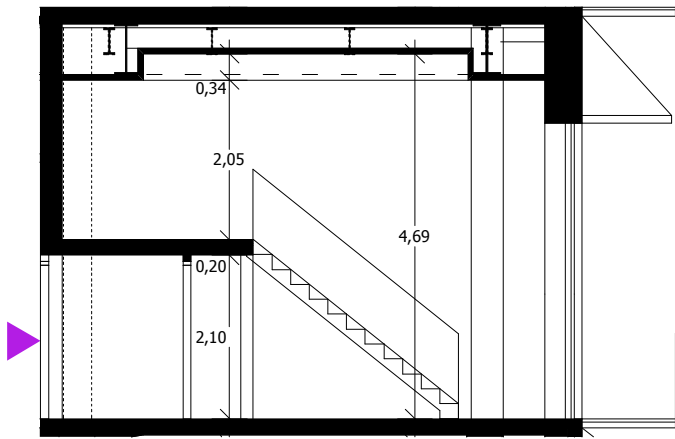

### 3. nadzemní podlaží

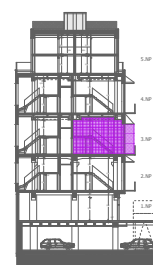

typ bytu:	1+kk loft
orientace:	východ
spodní patro:	34,07m <sup>2</sup>
galerie:	12,40m <sup>2</sup>
balkon:	7,39m <sup>2</sup>
terasa:	-
garážové stání	-
sklep	-

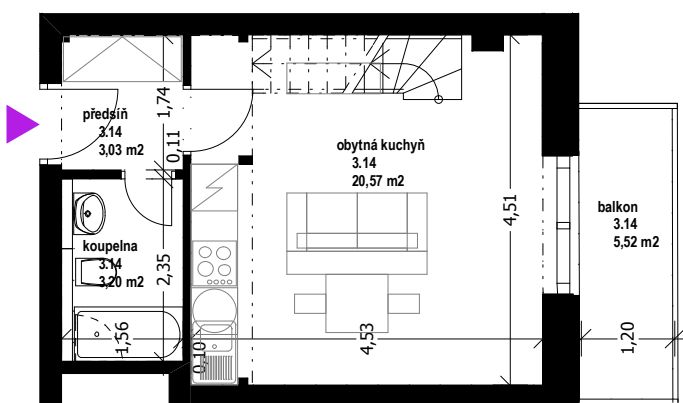
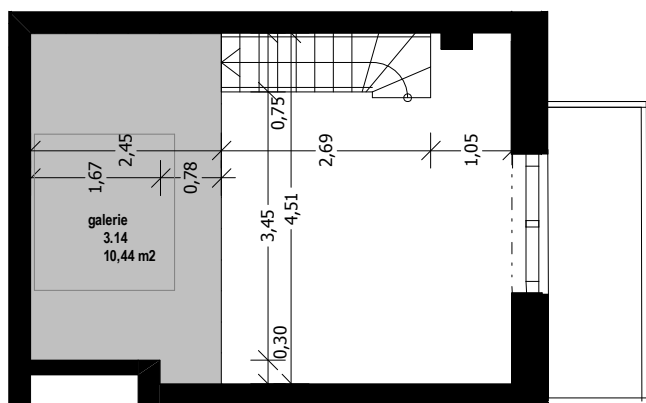
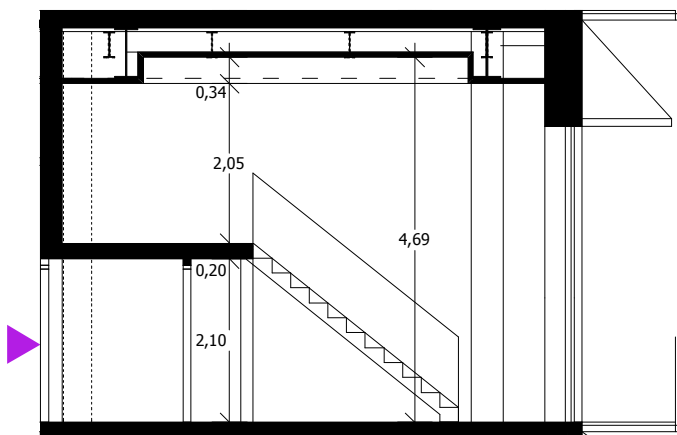

0 2 5  
1:100

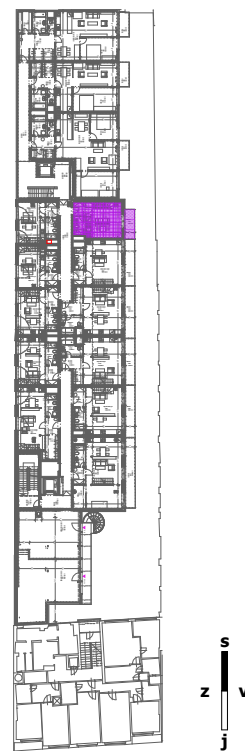

### 3. nadzemní podlaží

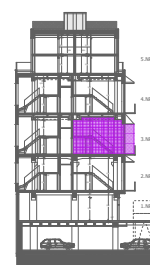

typ bytu:	1+kk loft
orientace:	východ
spodní patro:	26,80m <sup>2</sup>
galerie:	10,44m <sup>2</sup>
balkon:	5,52m <sup>2</sup>
terasa:	-
garážové stání	-
sklep	-

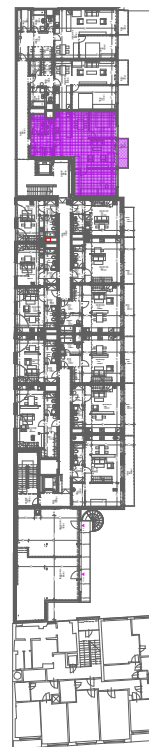
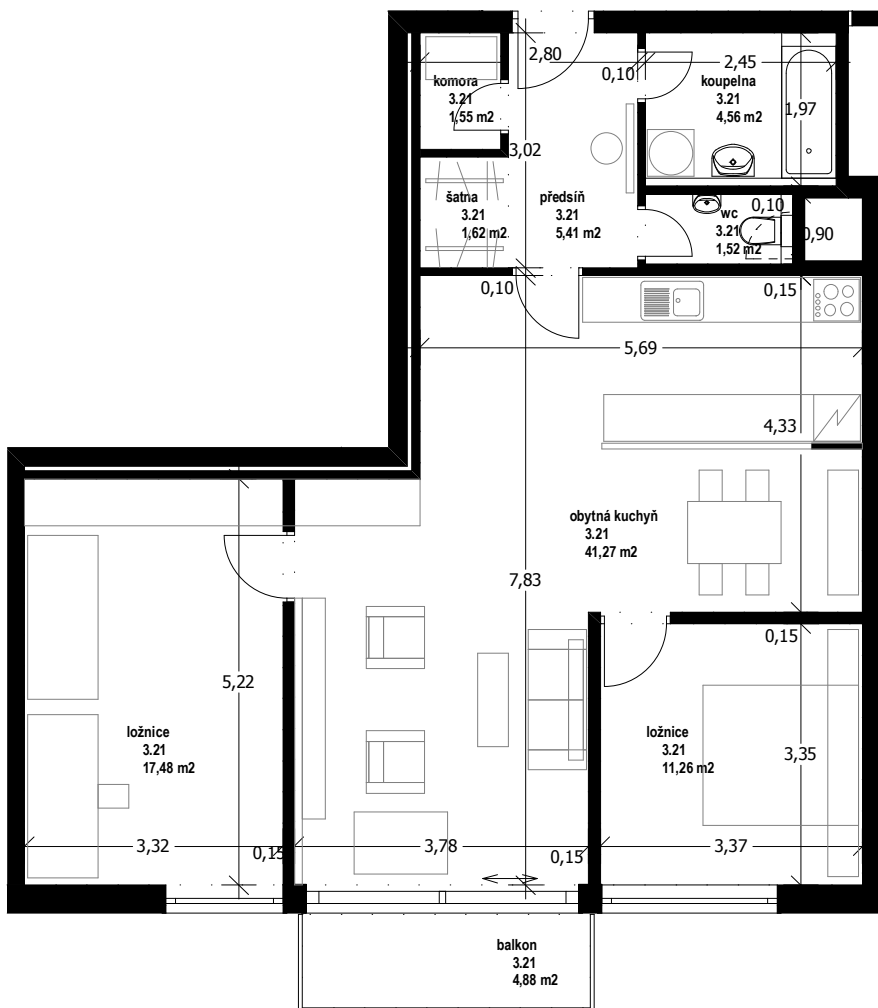

### 3. nadzemní podlaží

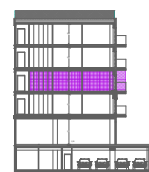

typ bytu:	3+kk
orientace:	východ
spodní patro:	84,67m <sup>2</sup>
galerie:	-
balkon:	4,88m <sup>2</sup>
terasa:	-
garážové stání	-
sklep	-

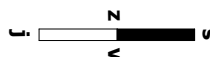
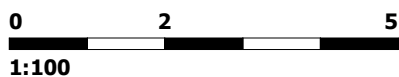

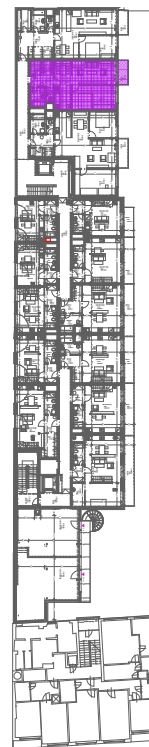
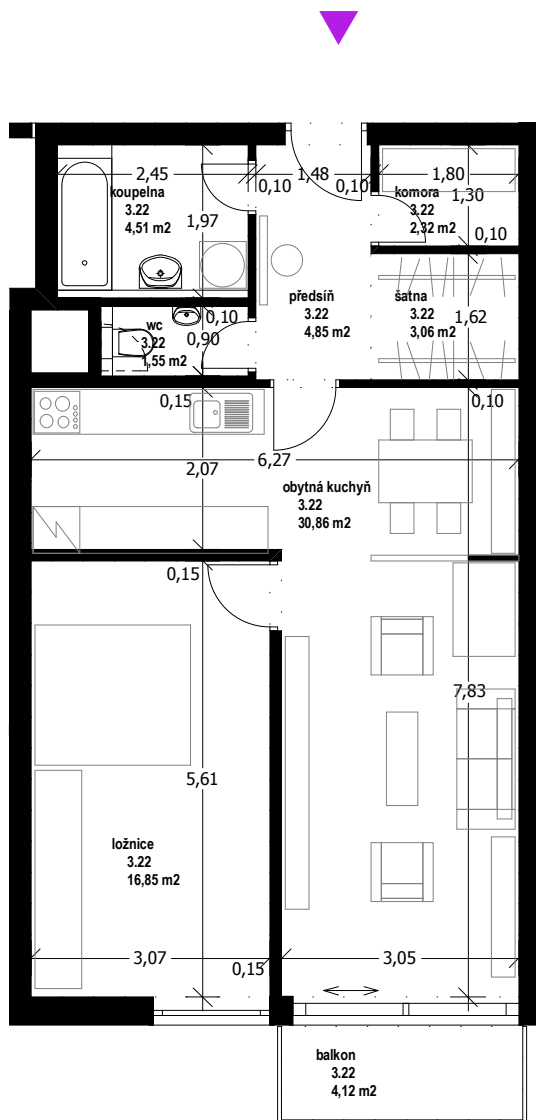

### 3. nadzemní podlaží

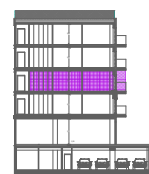

typ bytu:	2+kk
orientace:	východ
spodní patro:	64,01m <sup>2</sup>
galerie:	-
balkon:	4,12m <sup>2</sup>
terasa:	-
garážové stání	-
sklep	-

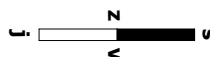
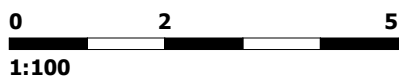

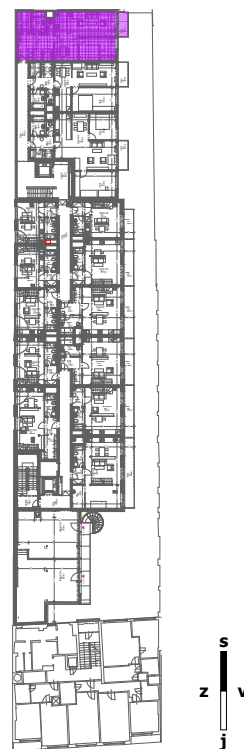
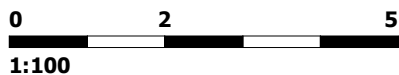
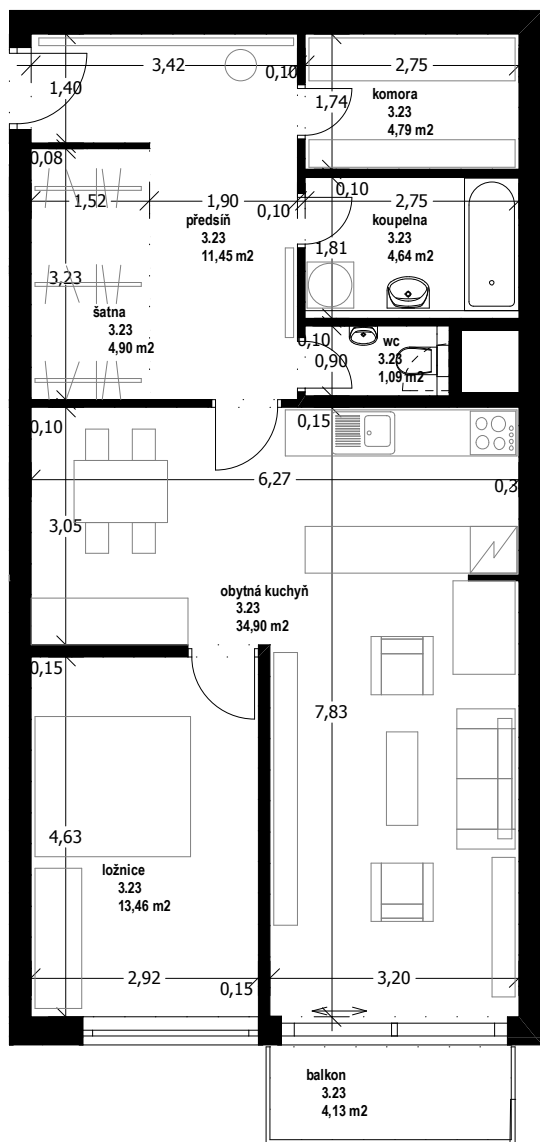

### 3. nadzemní podlaží

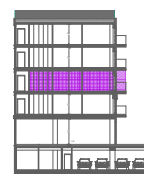

typ bytu:	2+kk
orientace:	východ
spodní patro:	75,24m <sup>2</sup>
galerie:	-
balkon:	4,13m <sup>2</sup>
terasa:	-
garážové stání	-
sklep	-

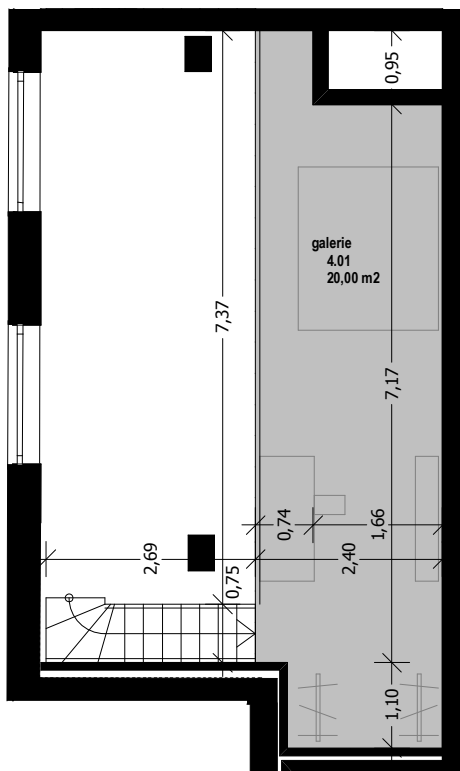
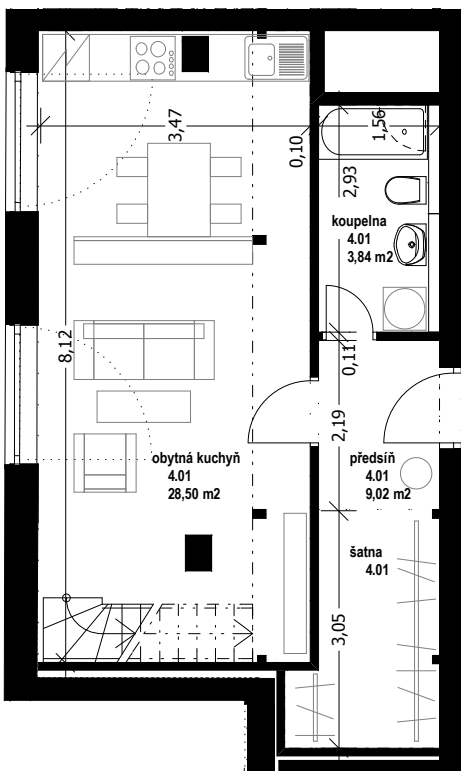
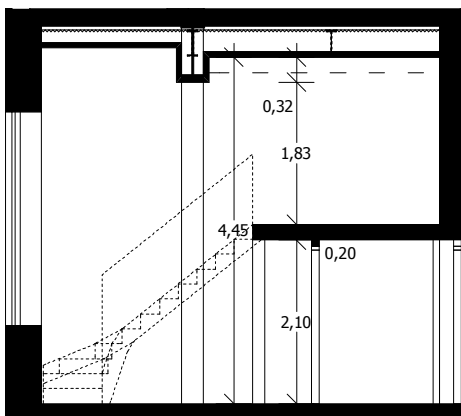

#### 4. nadzemní podlaží

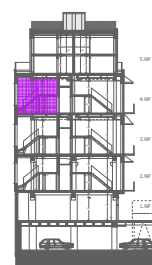

typ bytu:	1+kk loft
orientace:	západ
spodní patro:	41,37m <sup>2</sup>
galerie:	20,00 m <sup>2</sup>
balkon:	-
terasa:	-
garážové stání	-
sklep	-

0 2 5  
1:100



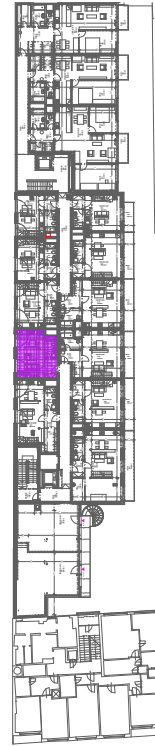
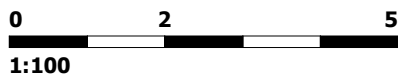
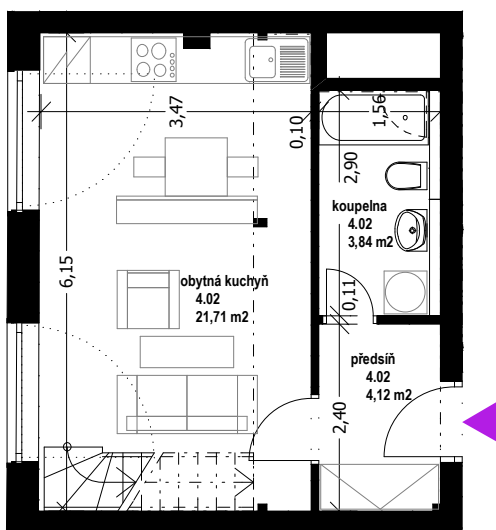
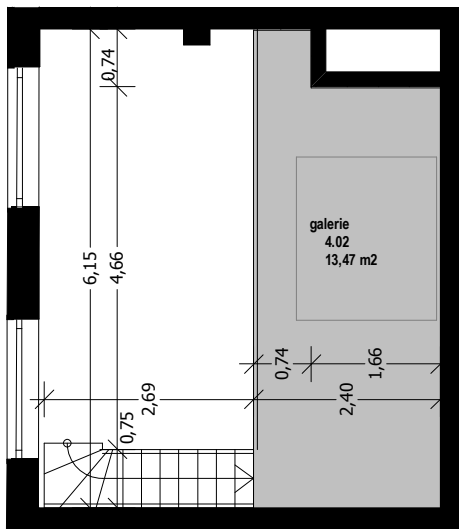
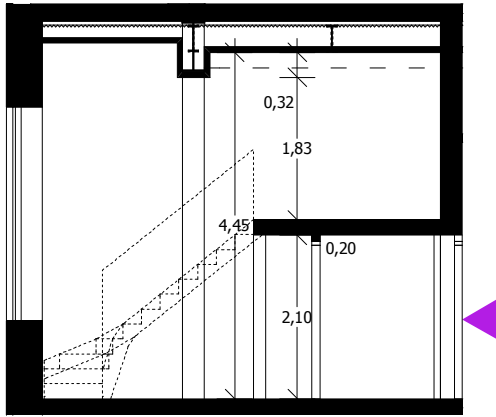

#### 4. nadzemní podlaží

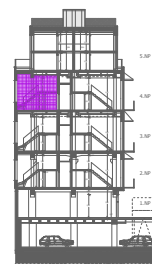

typ bytu:	1+kk loft
orientace:	západ
spodní patro:	29,67m <sup>2</sup>
galerie:	13,47m <sup>2</sup>
balkon:	-
terasa:	-
garážové stání	-
sklep	-





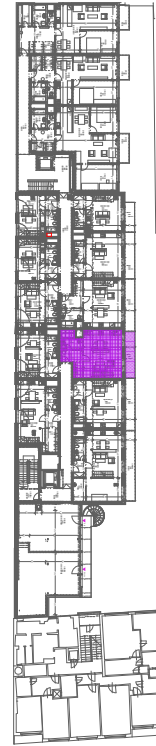
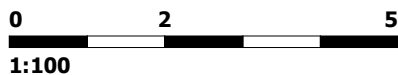
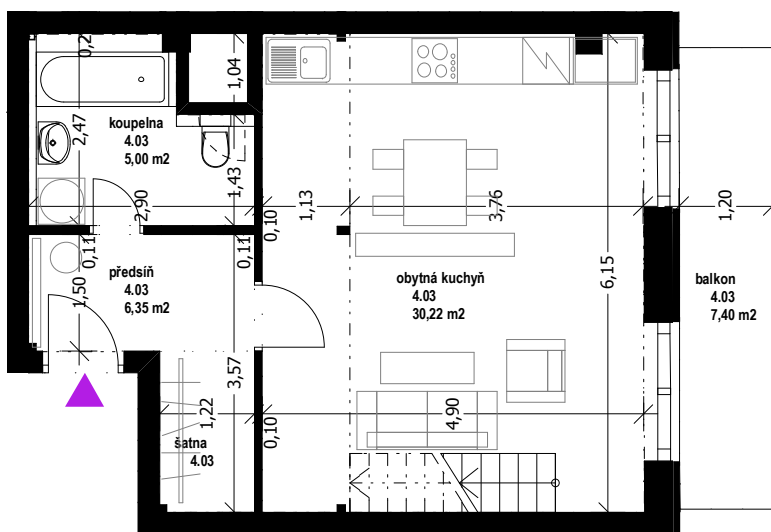
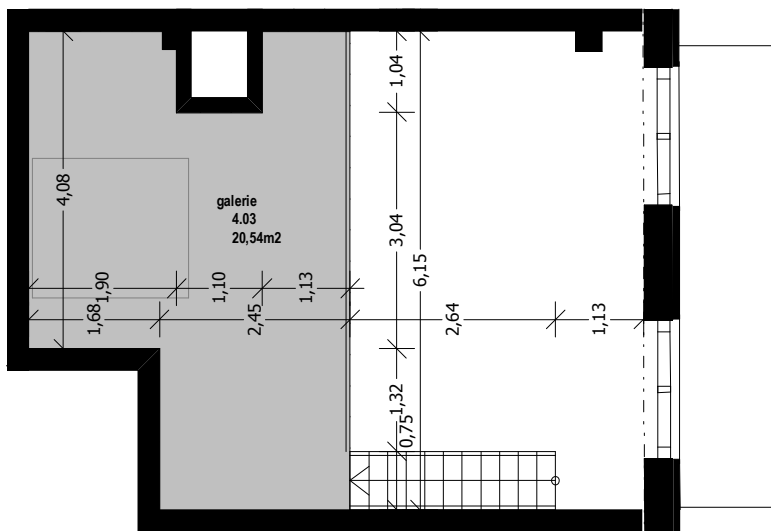
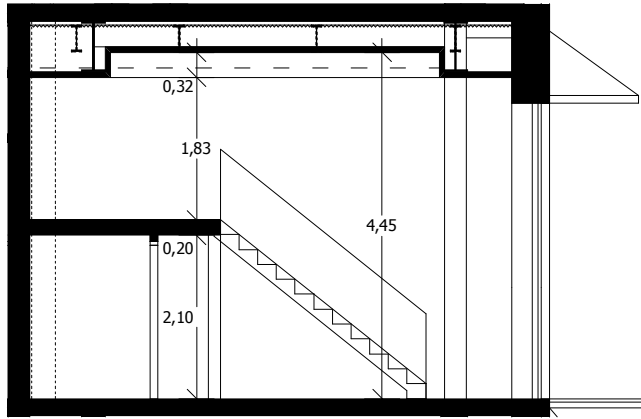

#### 4. nadzemní podlaží

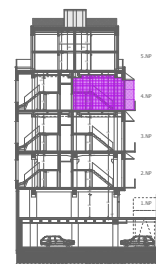

typ bytu:	1+kk loft
orientace:	východ
spodní patro:	41,56m <sup>2</sup>
galerie:	20,54m <sup>2</sup>
balkon:	7,40m <sup>2</sup>
terasa:	-
garážové stání	-
sklep	-

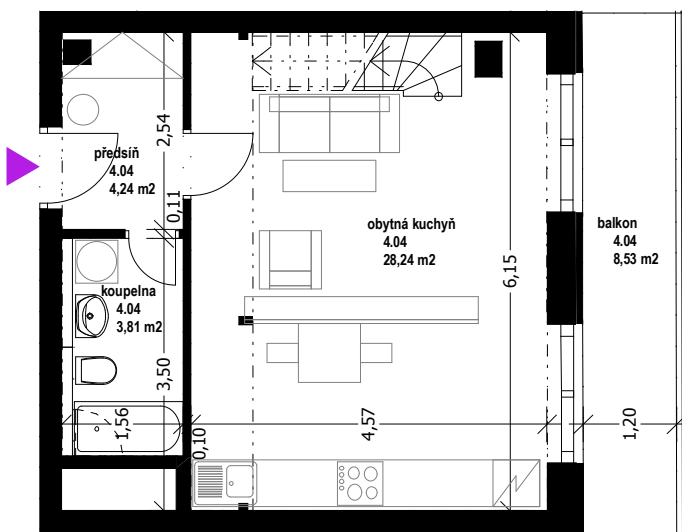
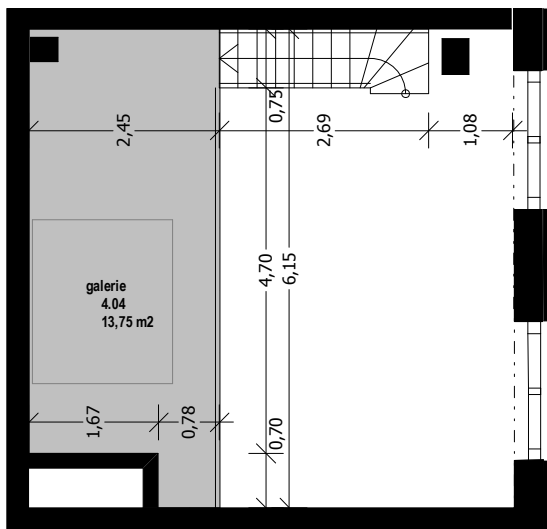
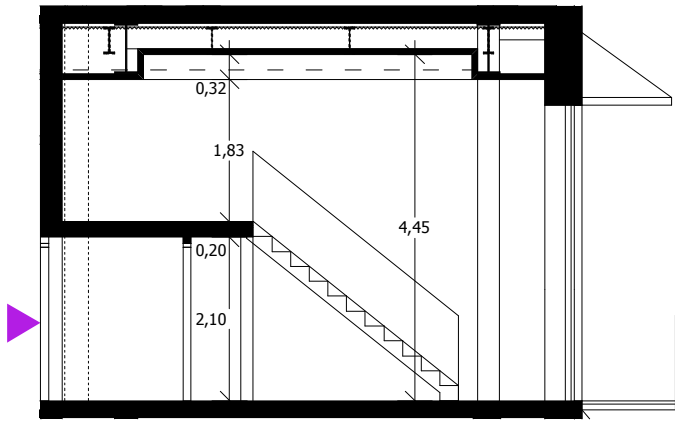

0 2 5  
1:100



#### 4. nadzemní podlaží

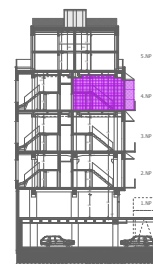

typ bytu:	1+kk loft
orientace:	východ
spodní patro:	36,30m <sup>2</sup>
galerie:	13,75m <sup>2</sup>
balkon:	8,53m <sup>2</sup>
terasa:	-
garážové stání	-
sklep	-

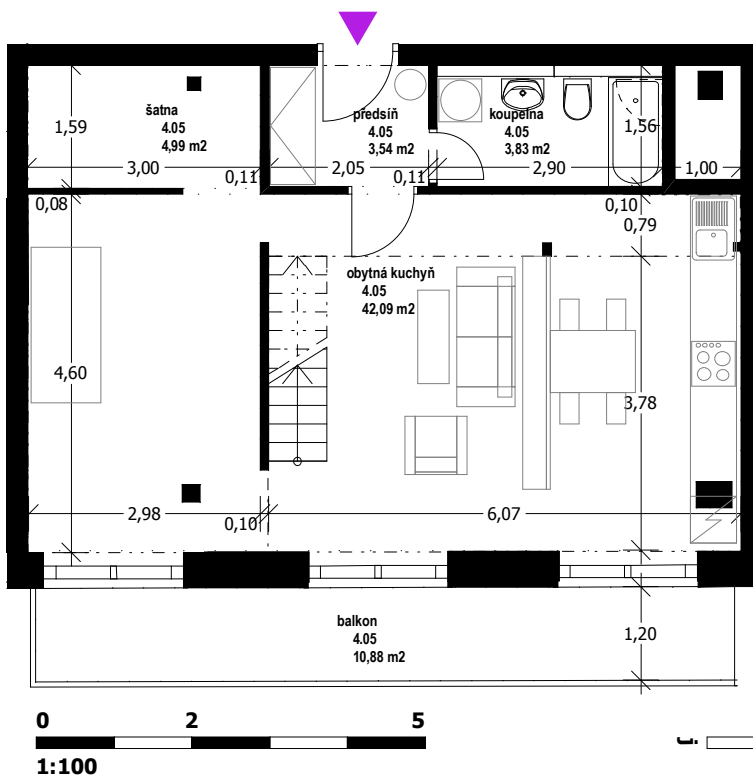
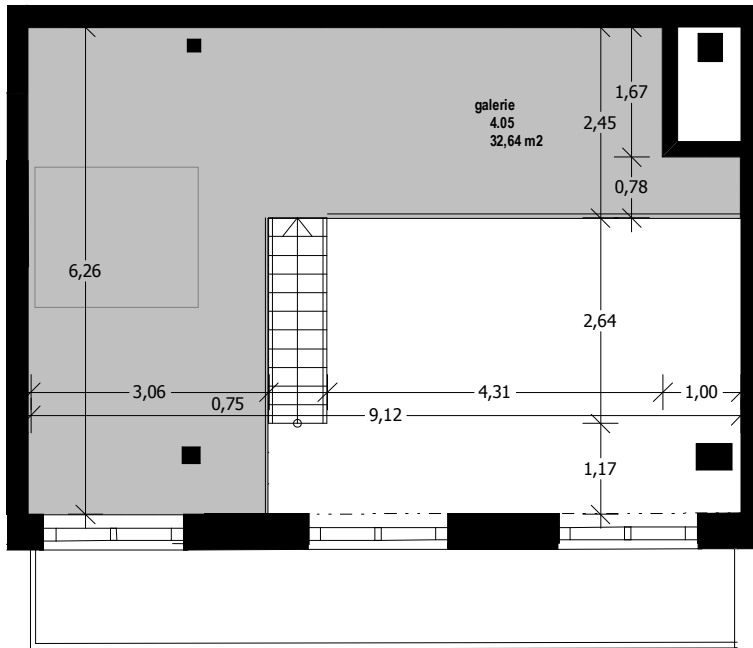
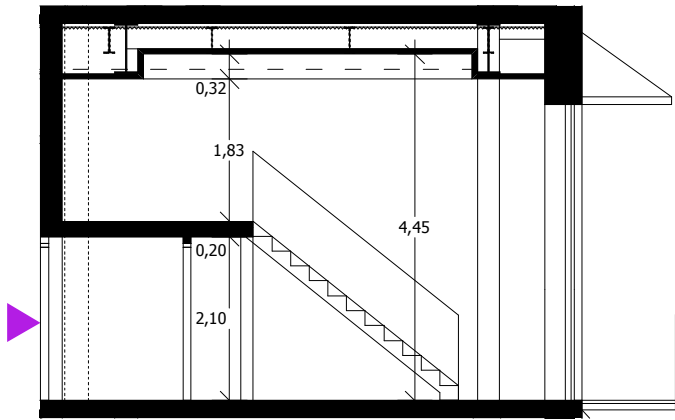

#### 4. nadzemní podlaží

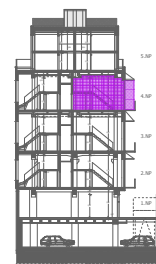

typ bytu:	1+kk loft
orientace:	východ
spodní patro:	54,45m <sup>2</sup>
galerie:	32,64m <sup>2</sup>
balkon:	10,88m <sup>2</sup>
terasa:	-
garážové stání	-
sklep	-

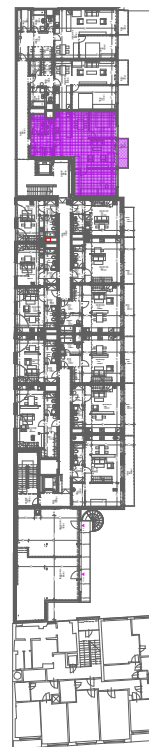
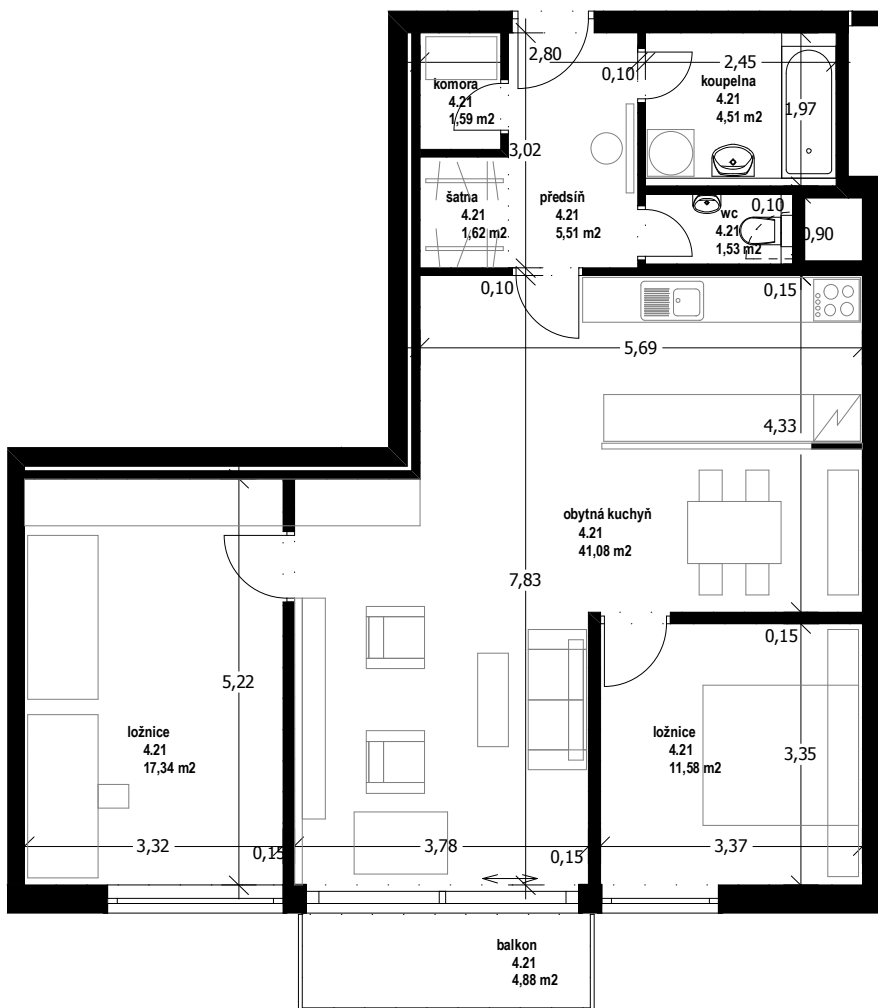

#### 4. nadzemní podlaží



typ bytu:	3+kk
orientace:	východ
spodní patro:	84,77m <sup>2</sup>
galerie:	-
balkon:	4,88m <sup>2</sup>
terasa:	-
garážové stání	-
sklep	-

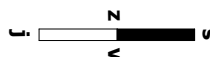
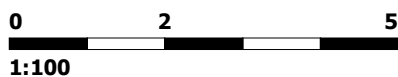

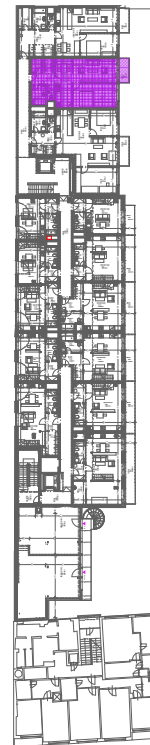
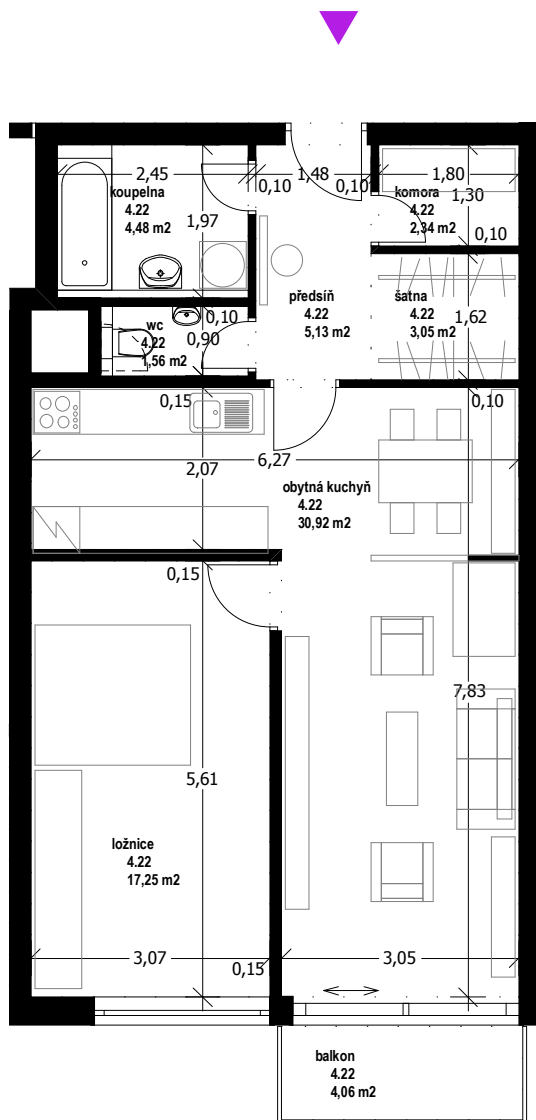

#### 4. nadzemní podlaží



typ bytu:	2+kk
orientace:	východ
spodní patro:	64,73m <sup>2</sup>
galerie:	-
balkon:	4,06m <sup>2</sup>
terasa:	-
garážové stání	-
sklep	-

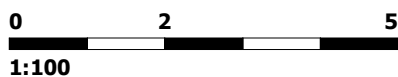

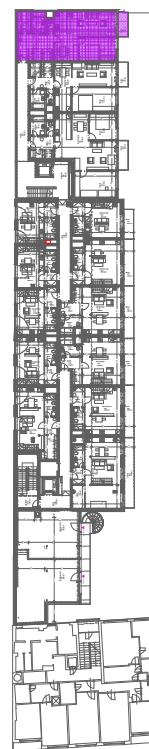
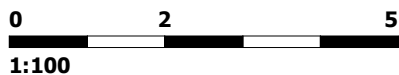
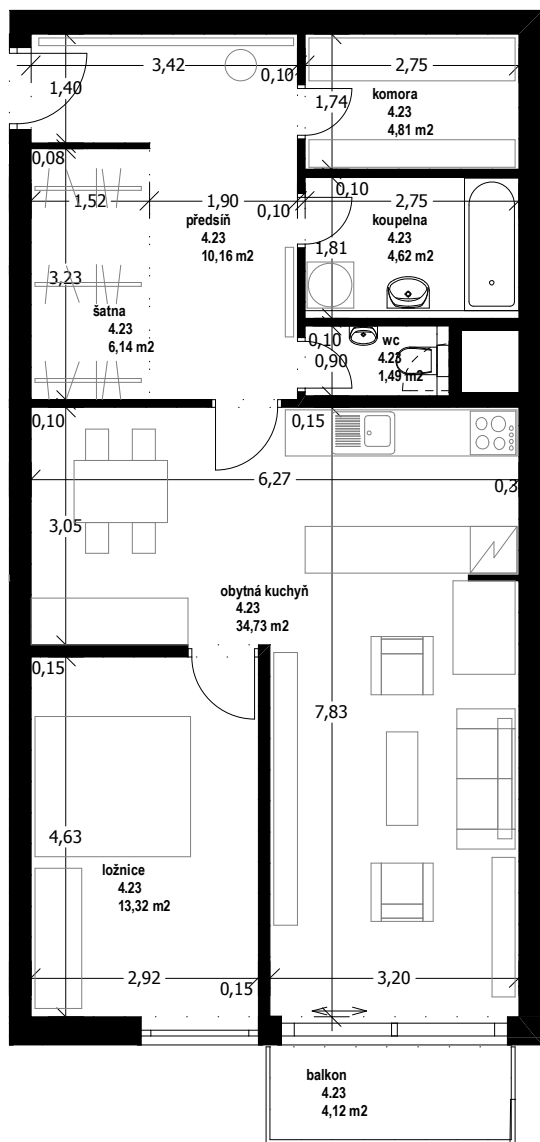

#### 4. nadzemní podlaží



typ bytu:	2+kk
orientace:	východ
spodní patro:	75,27m <sup>2</sup>
galerie:	-
balkon:	4,12m <sup>2</sup>
terasa:	-
garážové stání	-
sklep	-

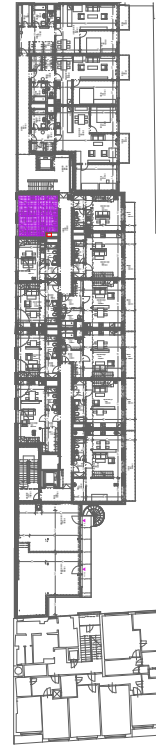
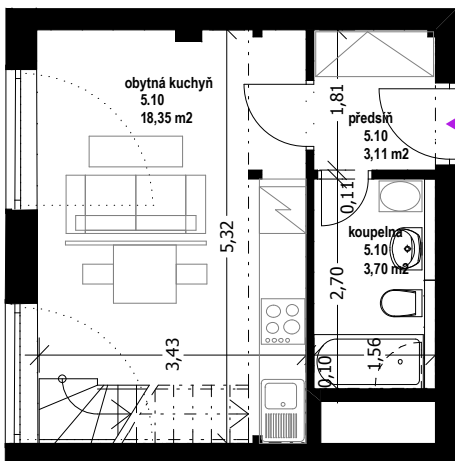
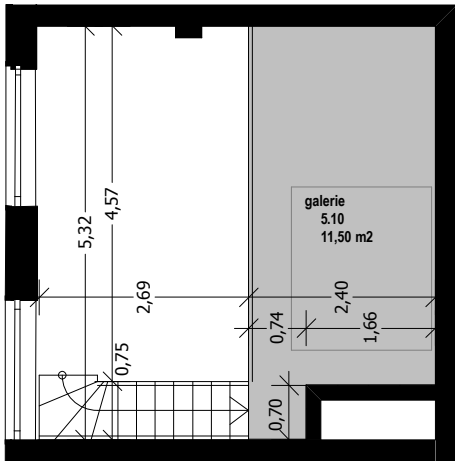
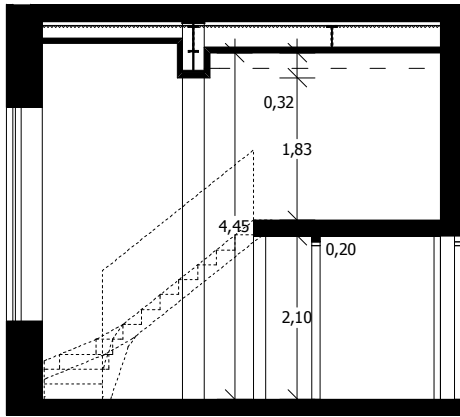

#### 4. nadzemní podlaží

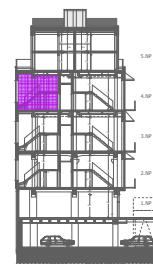

<b>typ bytu:</b>	<b>1+kk loft</b>
<b>orientace:</b>	<b>západ</b>
<b>spodní patro:</b>	<b>25,16m<sup>2</sup></b>
<b>galerie:</b>	<b>11,50m<sup>2</sup></b>
<b>balkon:</b>	-
<b>terasa:</b>	-
<b>garážové stání</b>	-
<b>sklep</b>	-



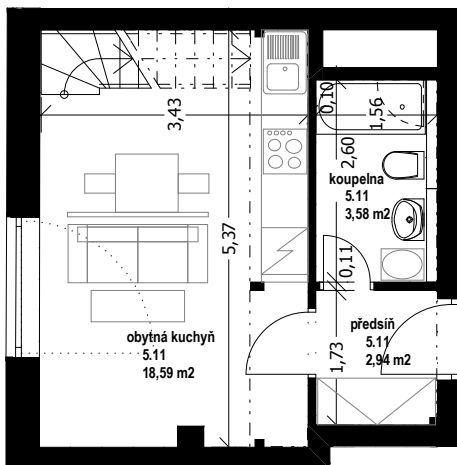
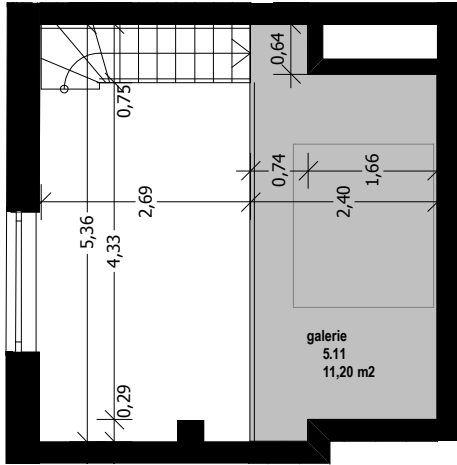
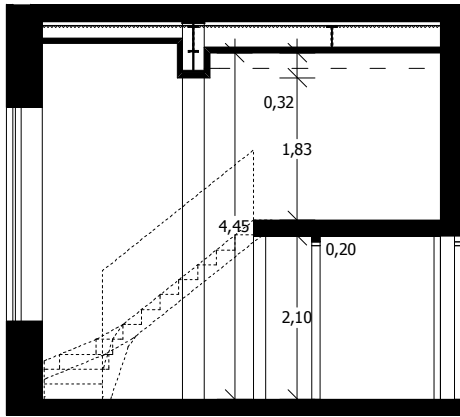

0 2 5  
1:100

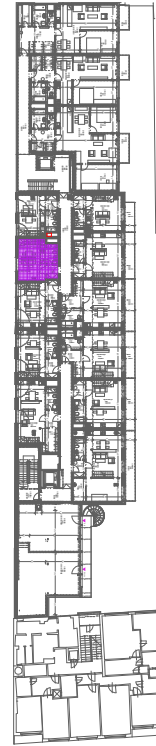

#### 4. nadzemní podlaží

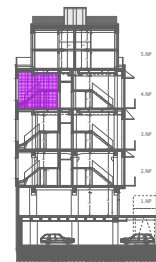

typ bytu:	1+kk loft
orientace:	západ
spodní patro:	25,12m <sup>2</sup>
galerie:	11,20m <sup>2</sup>
balkon:	-
terasa:	-
garážové stání	-
sklep	-



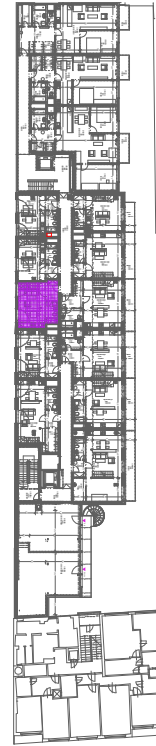
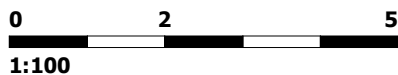
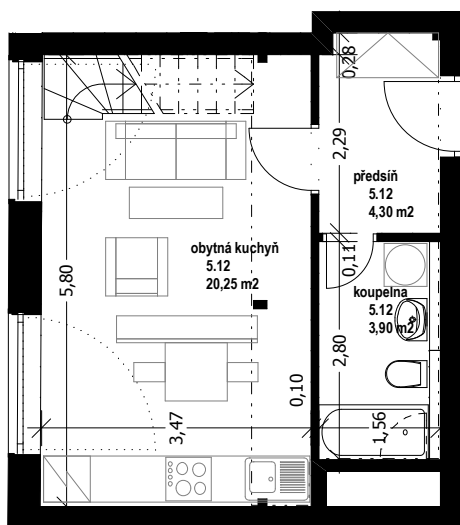
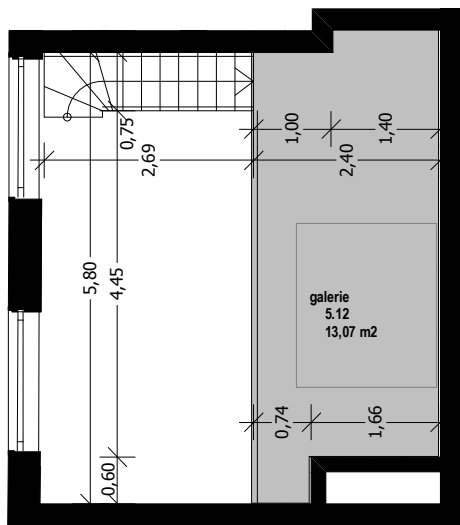
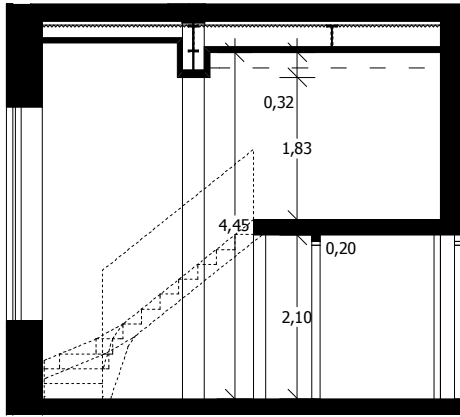

#### 4. nadzemní podlaží

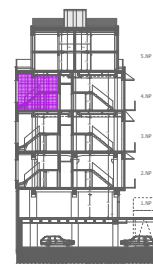

typ bytu:	1+kk loft
orientace:	západ
spodní patro:	28,45m <sup>2</sup>
galerie:	13,07m <sup>2</sup>
balkon:	-
terasa:	-
garážové stání	-
sklep	-

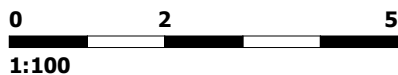
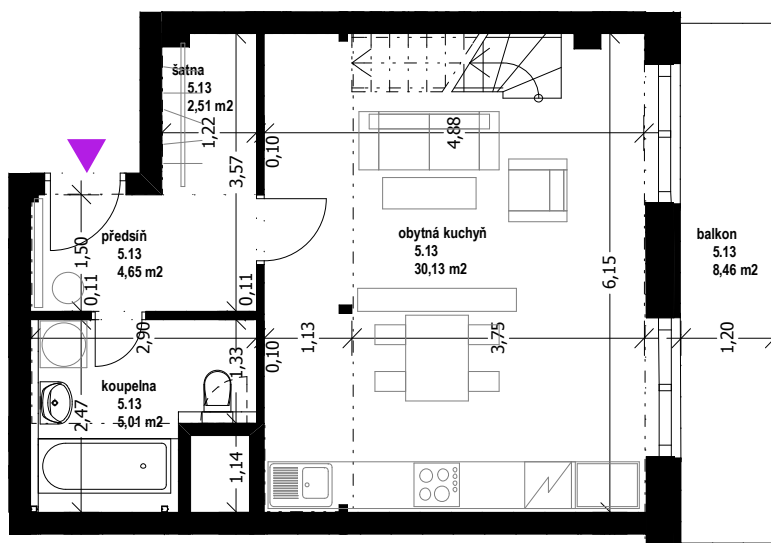
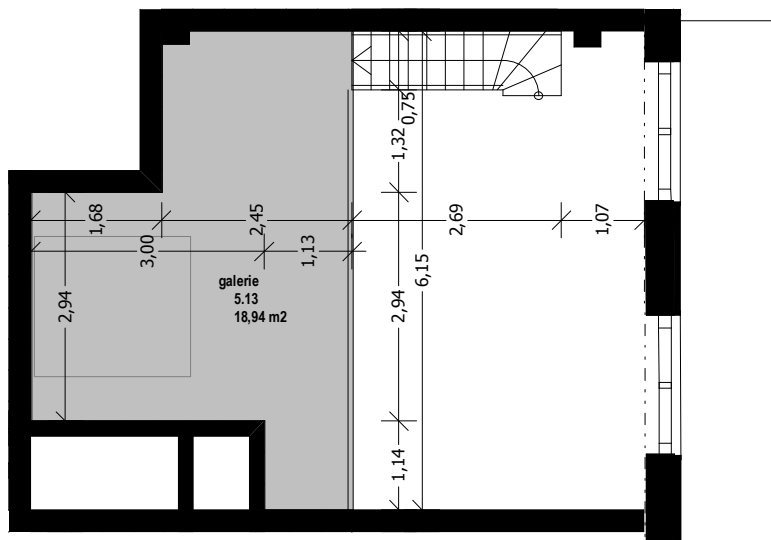
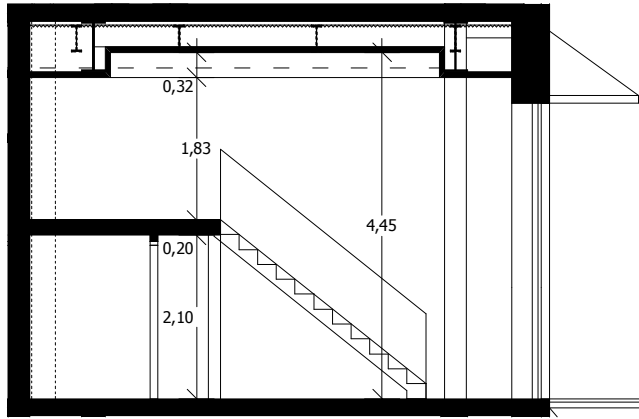

#### 4. nadzemní podlaží

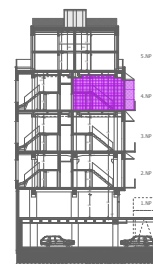

typ bytu:	1+kk loft
orientace:	východ
spodní patro:	42,31m <sup>2</sup>
galerie:	18,94m <sup>2</sup>
balkon:	8,46m <sup>2</sup>
terasa:	-
garážové stání	-
sklep	-

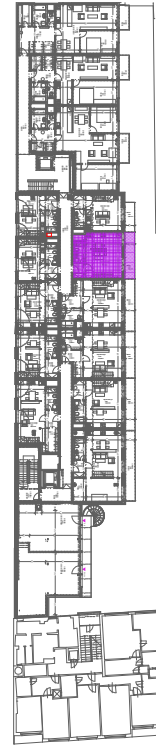
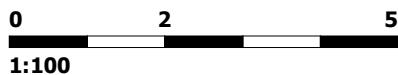
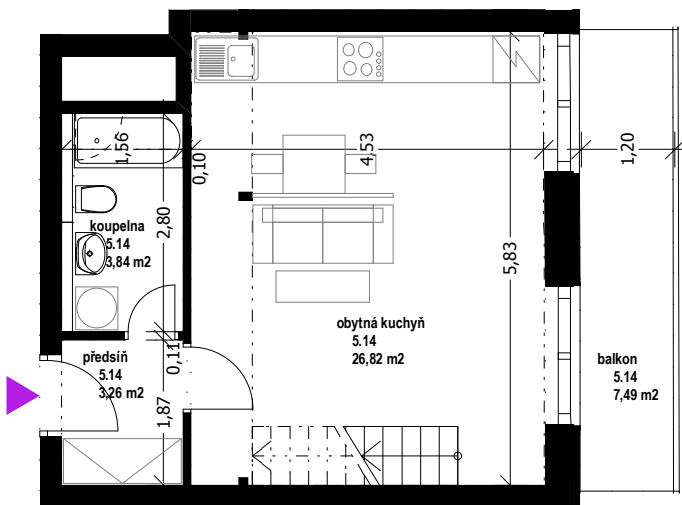
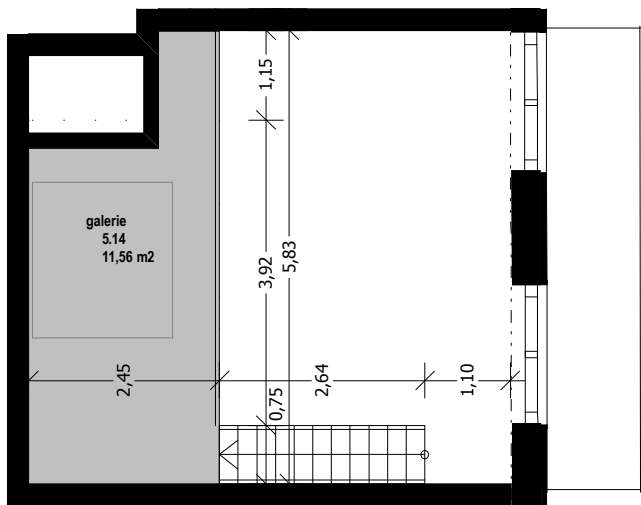
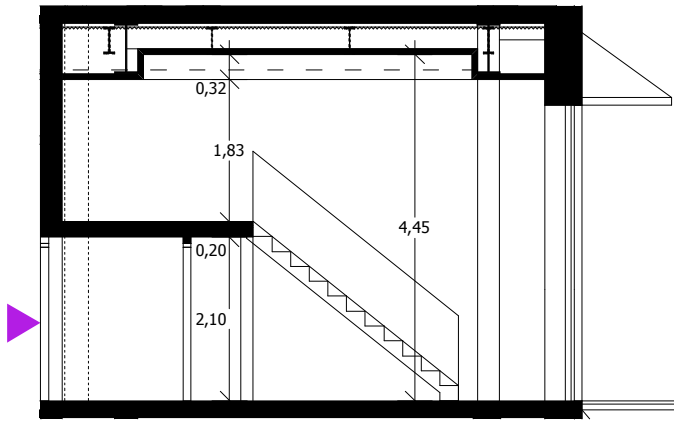

#### 4. nadzemní podlaží

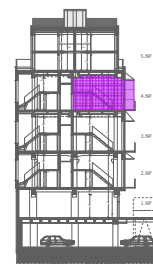

typ bytu:	1+kk loft
orientace:	východ
spodní patro:	33,92m <sup>2</sup>
galerie:	11,56m <sup>2</sup>
balkon:	7,49m <sup>2</sup>
terasa:	-
garážové stání	-
sklep	-



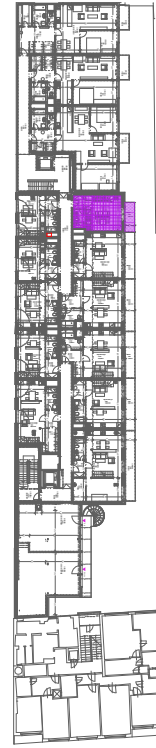
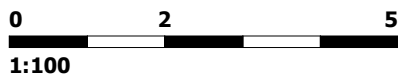
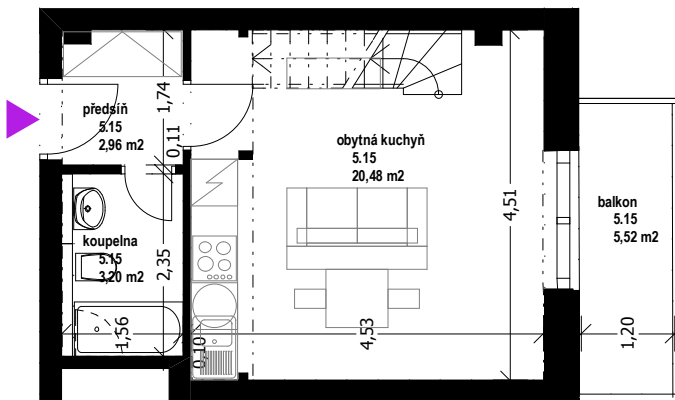
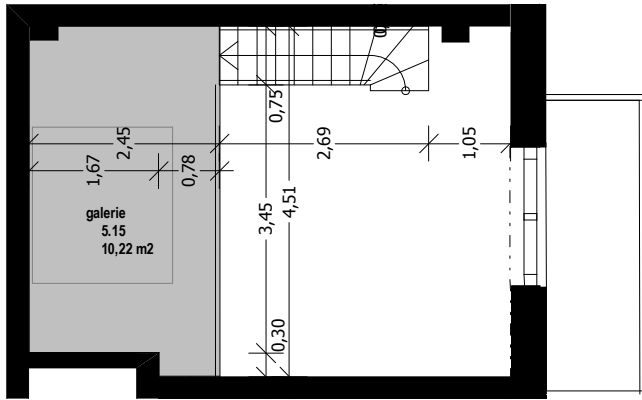
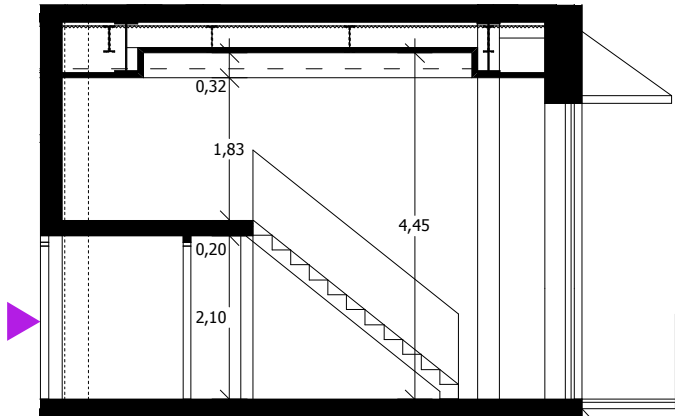

#### 4. nadzemní podlaží

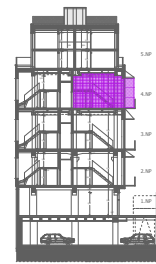

typ bytu:	1+kk loft
orientace:	východ
spodní patro:	26,64m <sup>2</sup>
galerie:	10,22m <sup>2</sup>
balkon:	5,52m <sup>2</sup>
terasa:	-
garážové stání	-
sklep	-

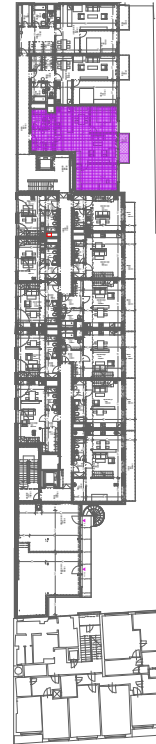
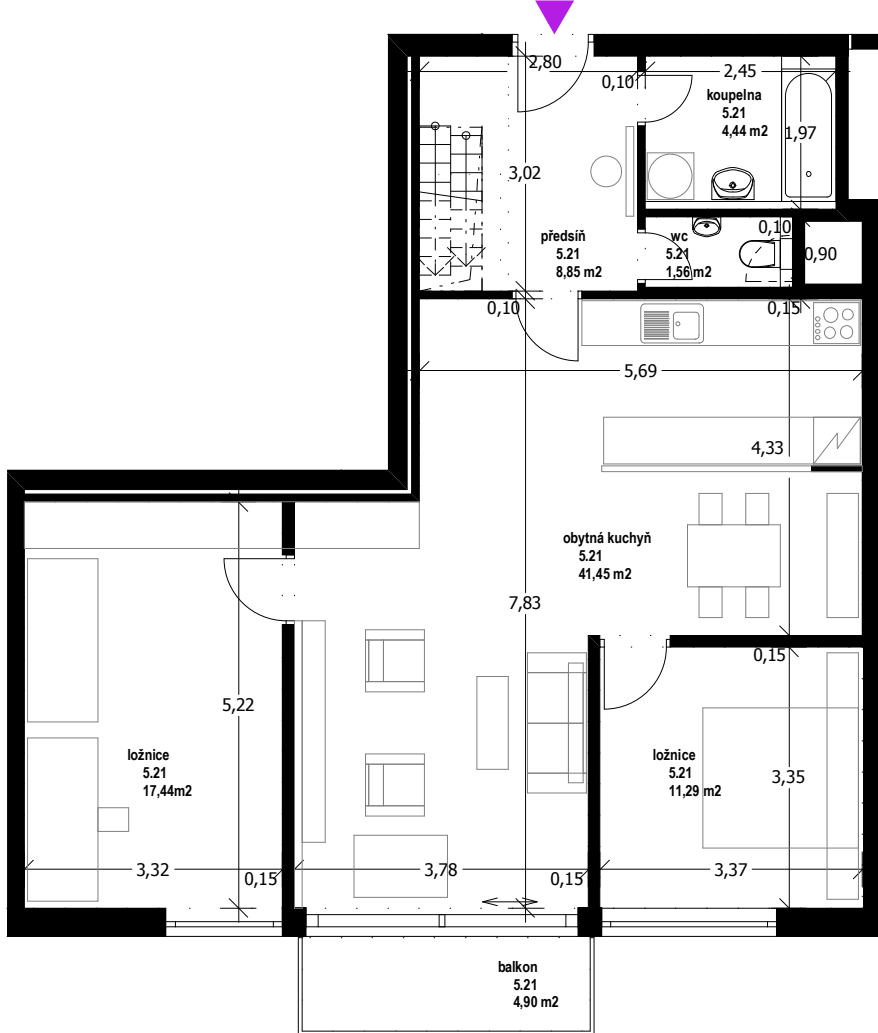

## 5. nadzemní podlaží



typ bytu:	3+kk
orientace:	východ
spodní patro:	85,02m <sup>2</sup>
galerie:	-
balkon:	4,90m <sup>2</sup>
terasa:	84,10m <sup>2</sup>
garážové stání	-
sklep	-

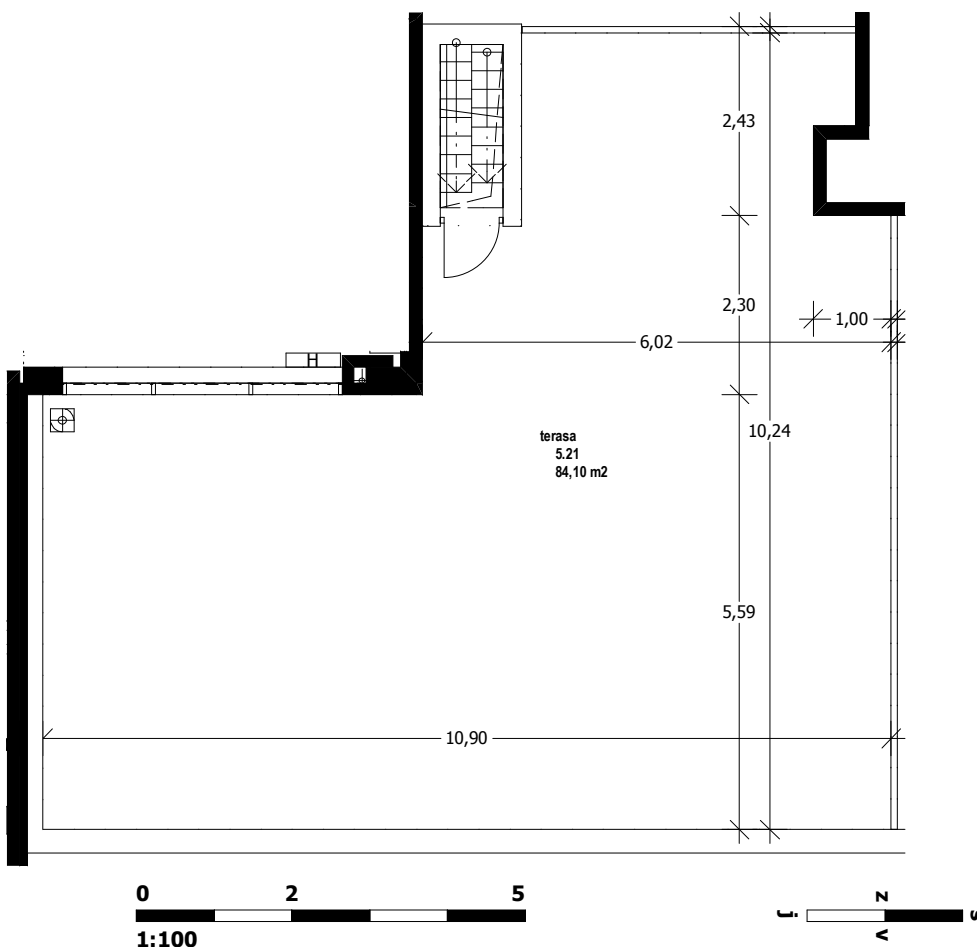

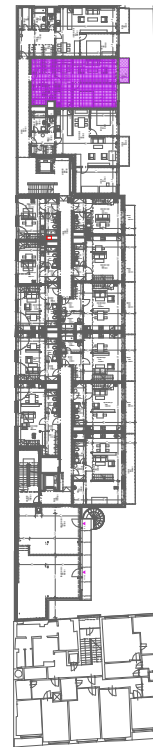
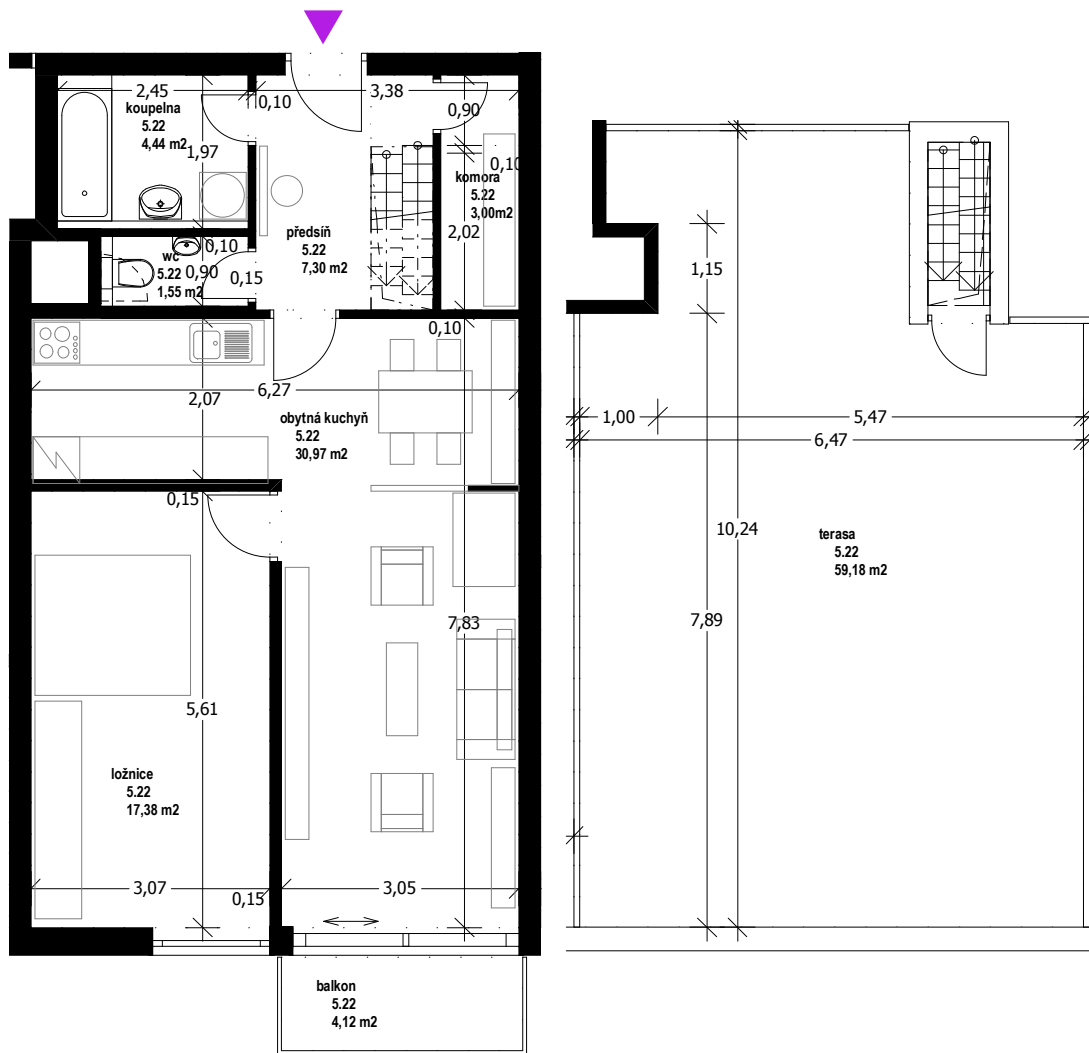

## 5. nadzemní podlaží



typ bytu:	1+kk
orientace:	východ
spodní patro:	64,63m <sup>2</sup>
galerie:	-
balkon:	4,12m <sup>2</sup>
terasa:	59,18m <sup>2</sup>
garážové stání	-
sklep	-

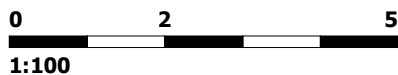

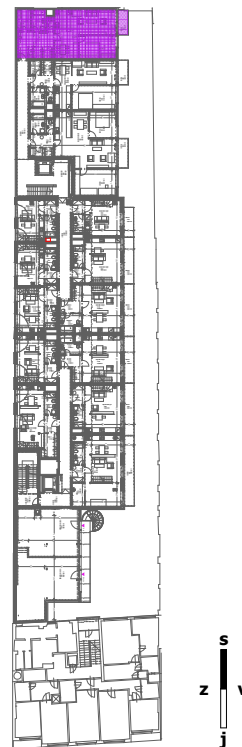
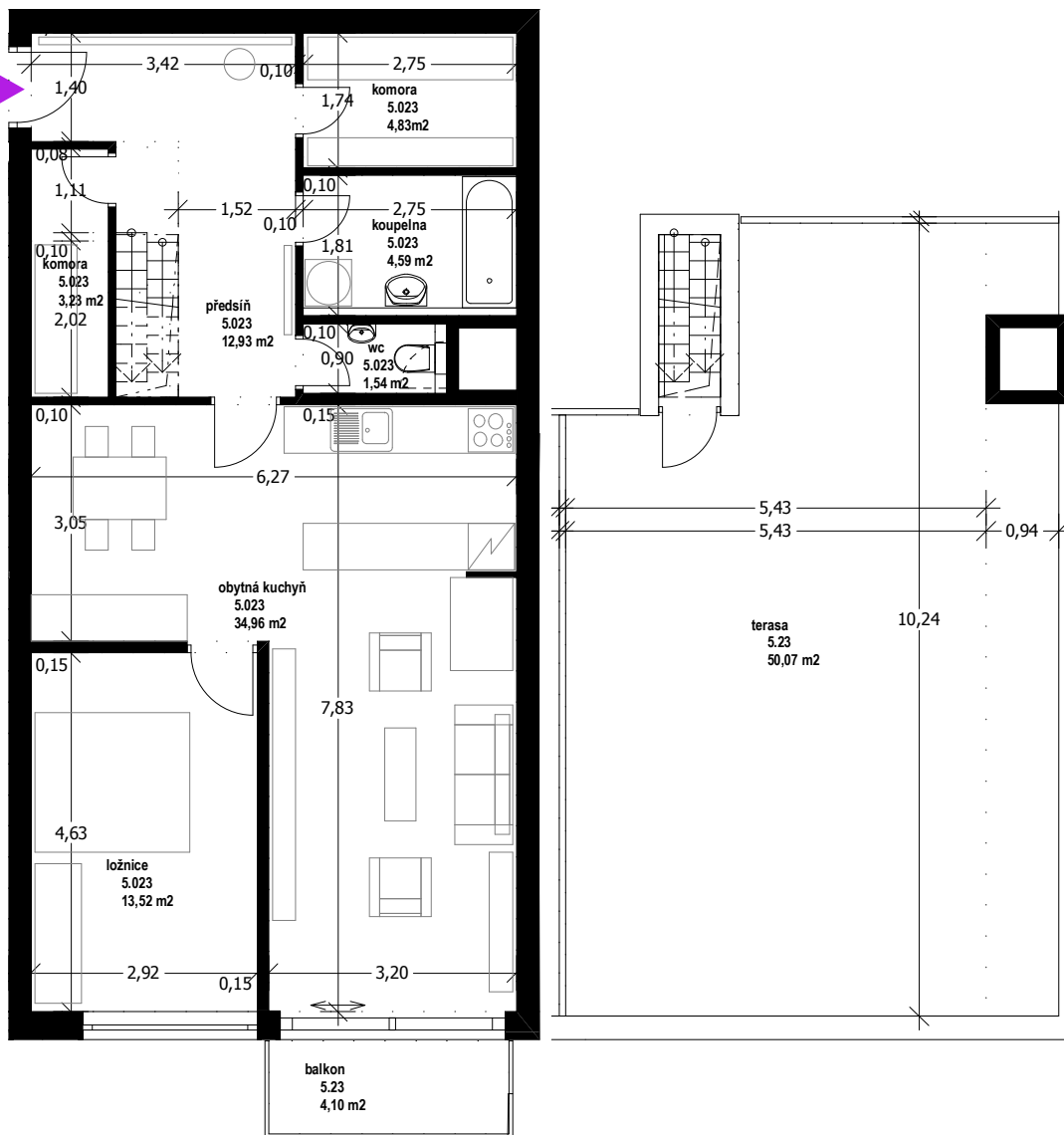

## 5. nadzemní podlaží

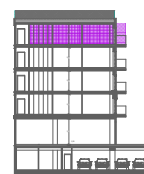

typ bytu:	1+kk
orientace:	východ
spodní patro:	75,61m <sup>2</sup>
galerie:	-
balkon:	4,10m <sup>2</sup>
terasa:	50,07m <sup>2</sup>
garážové stání	-
sklep	-

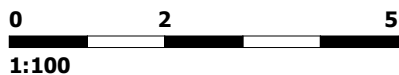





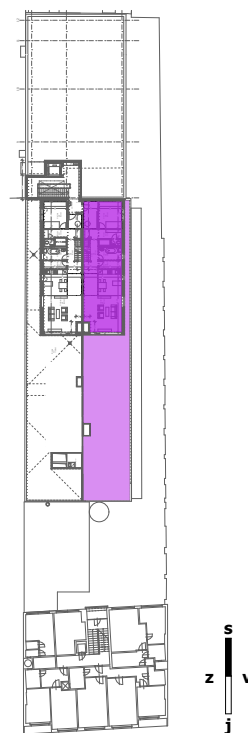
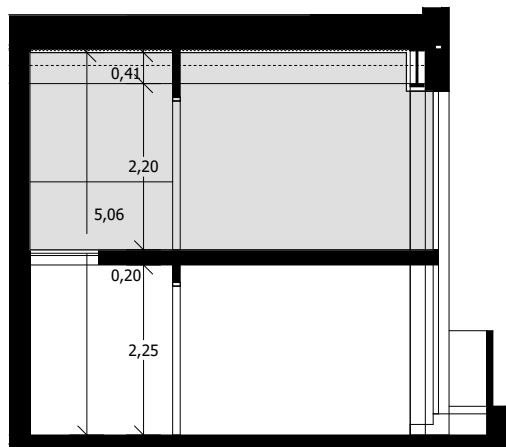
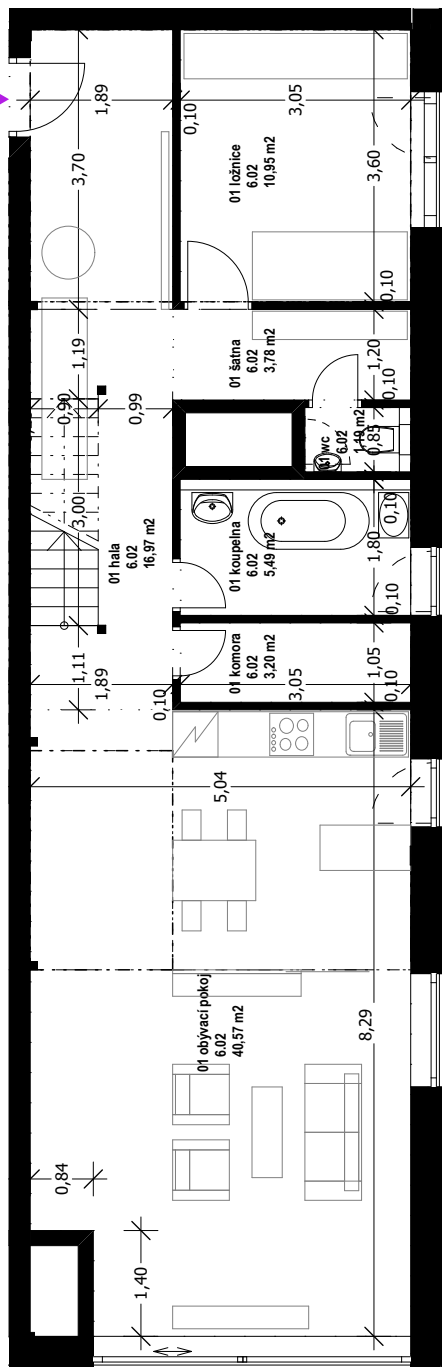
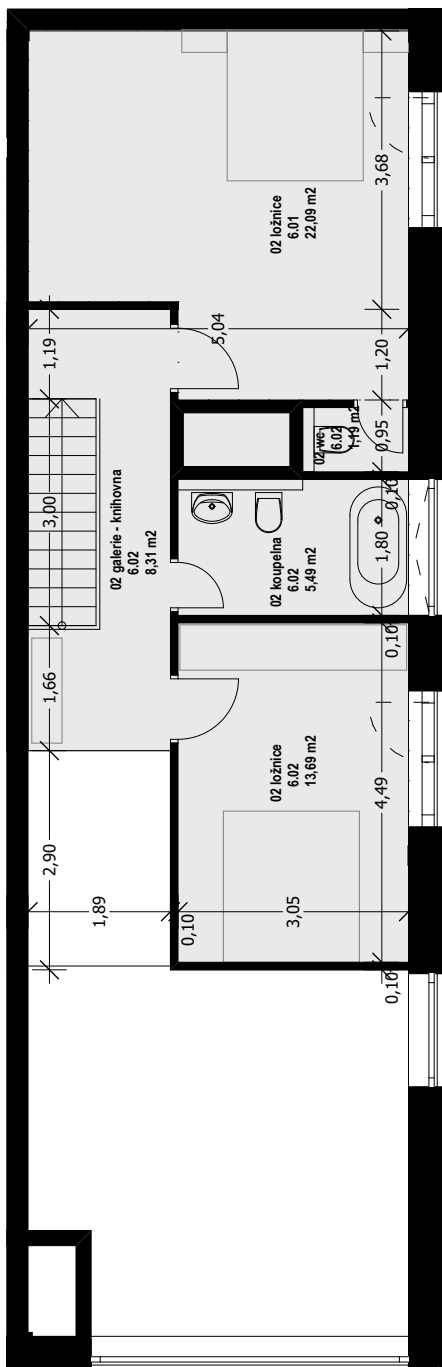

## 5. nadzemní podlaží

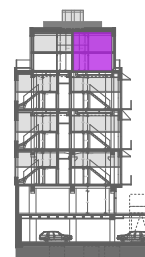

typ bytu:	4+kk loft
orientace:	jih, východ
spodní patro:	85,30 m <sup>2</sup>
galerie:	55,30 m <sup>2</sup>
balkon:	-
terasa:	140,00 m <sup>2</sup>
garážové stání	-
sklep	-

Residence Lofts Krizikova

REZIDENCE LOFTS  
KRIZIKOVA

byt: 6.02